



TECHNIMOUNT
EMS™

SAFETY MD-TRANSPORTER®

USER GUIDE



COPYRIGHT

Copyright 2021 Technimount E.M.S. Holding Inc. (Technimount), an affiliated company of Technologies CGC Inc. All Rights Reserved. No part of this publication may be reproduced, transmitted, transcribed, stored in a retrieval system, or translated into any language in any form or by any means without the written permission of Technimount or its affiliate companies.

Trademark Attributions

Safety MD-Transporter® is a registered trademark of Technologies CGC Inc.

Stryker, PowerPro-XT and Mx-Pro are registered trademarks from Stryker.

Technimount does not have any commercial relationship with Strkyer. Stryker does not promote or sell Technimount products.

In order to ensure continuous improvements to our products and services, we invite you to communicate your comments to our Customer Service Department at customerservice@technimount.com.

CONTACT INFORMATION

OFFICE ADDRESS

TECHNIMOUNT E.M.S. HOLDING INC.
3770 Jean Marchand Street, Suite 100-C
Quebec (QC) G2C 1Y6
Canada

info@technimount.com

www.technimount.com

T + 1 581.700.6631

TF +1 888.639.2758

NOTE

For any issues with your Technimount product, its components, or for any technical questions during the installation or maintenance, please send an email to techsupport@technimount.com.

Please have the serial number of your Technimount product available (as shown in the figure below) when calling Technimount Customer Service or Technical Support. Include the serial number in all written communications.

SERIAL NUMBER LOCATION

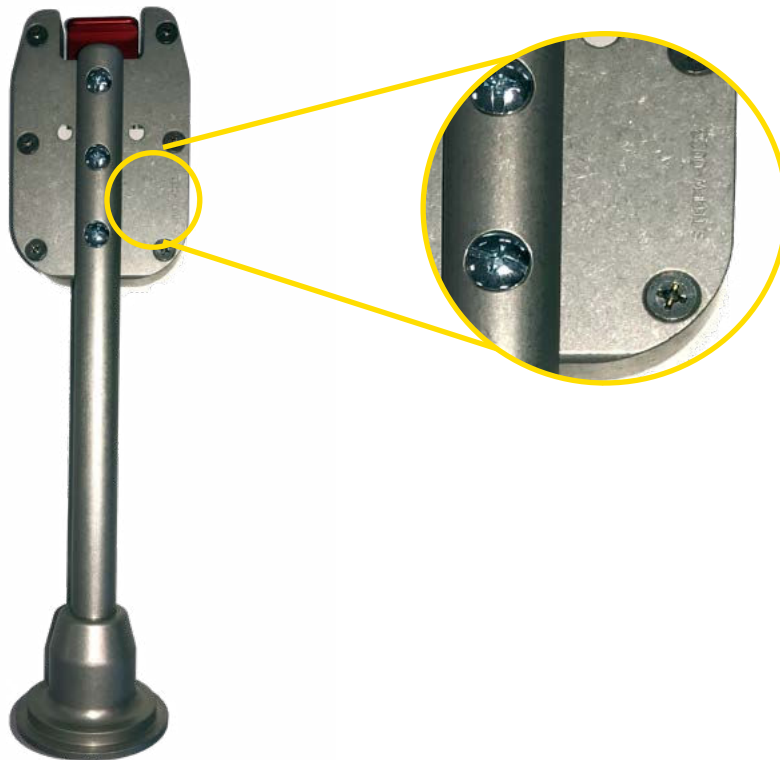

[Return To Table of Contents](#)



TABLE OF CONTENTS

COPYRIGHT	2
CONTACT INFORMATION.....	3
SYMBOLS AND DEFINITIONS	6
WARNING / CAUTION / NOTE.....	7
IDENTIFICATION OF COMPONENTS.....	8
<i>MICRO BASE</i>	8
<i>SAFETY MD-TRANSPORTER</i>	8
TECHNICAL SPECIFICATIONS.....	9
INTRODUCTION	10
PURPOSE OF THE DOCUMENT	10
PRODUCT DESCRIPTION	10
INTENDED USE OF THE PRODUCT	10
PRODUCT ILLUSTRATION.....	11
NOTICE	12
INSTALLATION GUIDE	13
REMOVING PACKAGING FOR INSTALLATION	13
TOOLS REQUIRED FOR INSTALLATION.....	13
SAFETY MD-TRANSPORTER INSTALLATION	14
<i>INSTALLING THE MICRO BASE ON AN ADAPTER PLATE OR SURFACE</i>	14
<i>INSTALL SAFETY MD-TRANSPORTER INTO MICRO BASE</i>	15
<i>REMOVE THE SAFETY MD-TRANSPORTER</i>	15
SUMMARY OF SAFETY PRECAUTIONS	16
WARNING/CAUTION/NOTE	16
OPERATION GUIDE	18
GENERAL OPERATING GUIDELINES.....	18
OPERATING BRACKET WITH THE SAFETY MD-TRANSPORTER®.....	19
<i>INSTALLING THE BRACKET ONTO THE SAFETY MD-TRANSPORTER®</i>	19
<i>ROTATING THE BRACKET ON THE SAFETY MD-TRANSPORTER</i>	20
<i>REMOVING THE BRACKET FROM THE SAFETY MD-TRANSPORTER</i>	21
MOUNTING SYSTEM PART NUMBERS.....	22
KITS AND OTHER OPTIONS.....	22
<i>SAFETY MD-TRANSPORTER WITH THE VERTICAL MICRO BASE</i>	22
<i>SAFETY MD-TRANSPORTER WITH THE HORIZONTAL MICRO BASE - VERSION 2</i>	22
MAINTENANCE GUIDE.....	23
CLEANING THE SAFETY MD-TRANSPORTER.....	23
<i>CLEANING PROCESS</i>	23
<i>CLEANING SOLUTIONS</i>	23
<i>REMOVAL OF IODINE COMPOUNDS</i>	24
PREVENTIVE MAINTENANCE.....	24
<i>LUBRICATION</i>	24
INSPECTION PROCESS AND SCHEDULE.....	25
<i>PREVENTIVE MAINTENANCE PROGRAM</i>	25
INSPECTION AND MAINTENANCE RECORD.....	26
TRAINING RECORD.....	27
REPLACEMENT PARTS.....	28
<i>SAFETY MD-TRANSPORTER WITH THE VERTICAL MICRO BASE - VERSION 1</i>	28

TABLE OF CONTENTS



<i>SAFETY MD-TRANSPORTER WITH THE HORIZONTAL MICRO BASE - VERSION 2</i>	28
WARRANTY	29
WARRANTY POLICY	29
LIMITED RESPONSIBILITY AND WARRANTY.....	29
INTERNATIONAL WARRANTY CLAUSE	29
RETURN POLICY.....	30
<i>PRIOR TO 30 DAYS</i>	30
<i>PRIOR TO 45 DAYS</i>	30
<i>PRIOR TO 60 DAYS</i>	30
RETURN AUTHORIZATION.....	30
DAMAGED MERCHANDISE.....	31
CLAIM PROCESS	31
<i>REQUIRED INFORMATION</i>	31
<i>FINDINGS AND CONCLUSION</i>	31
QUESTIONS ABOUT OUR POLICY.....	31
BOLT PATTERN	32
SAE CERTIFICATION	34

SYMBOLS AND DEFINITIONS

SYMBOL	DESCRIPTION
	Warning and Caution, special attention is required. Consult accompanying documents
	Safe working load symbol and Load balance symbol
	Pinch Point

WARNING / CAUTION / NOTE

The word warning, caution, or note carry special meaning and should be carefully reviewed.

SYMBOL	DESCRIPTION
	<p>WARNING</p> <p>Alerts the reader about a situation which, if not avoided, could result in death or serious injury. It may also describe potential serious adverse reactions and safety hazards.</p>
	<p>CAUTION</p> <p>Alerts the reader of a potentially hazardous situation, which, if not avoided, may result in minor or moderate injury to the user or patient or damage to the equipment or other property. This includes special care necessary for the safe and effective use of the device to avoid damage that may occur as a result of use or misuse.</p>
<p>NOTE</p>	<p>Provides special information about the product.</p>

IDENTIFICATION OF COMPONENTS

MICRO BASE

- The round base of the Safety MD-Transporter® inserts into the Micro Base.
- The locking mechanism secures the Safety Transporter in place.
- The red quick release button is used to quickly release the device from the Micro Base.



SAFETY MD-TRANSPORTER

- The Safety MD-Transporter® post is provided with a Micro Base.
- It has a round base at the bottom which inserts into the Micro Base.
- It can rotate 360° for easy access to the medical device.
- The Micro Base on the top of the Safety MD-Transporter® is used to hold the medical device.
- The Safety MD-Transporter® can hold a maximum weight of 25 pounds.



INTRODUCTION

TECHNICAL SPECIFICATIONS

Product Name	Safety MD-Transporter®
Product Description	Bracket mounting system to secure medical devices on the left or right side of a stretcher or on a shelf in an air or ground ambulance during EMS and Critical Care Transport
Cot/Stretcher Compatibility*	Stryker® ProXT, PowerPro, model 6085-6086, 6500 and 6505 Other custom solutions for air or ground ambulance counter installation
Environment of Usage	EMS (Ground & Flight) – Hospital/Clinic, Military
Product Section Material	<ul style="list-style-type: none">Safety MD-Transporter®: Aluminum 6061-T6 Pole with Stainless Steel 304 BaseMicro Base: Aluminum 6061-T6
Product Finish	<ul style="list-style-type: none">Safety MD-Transporter®: Silver-Anodized FinishMicro Base: Silver-Anodized Finish
Environmental Regulations	Complying with RoHS 3
Temperature of Usage	- 35° C to 45° C
Certification	Tested in Compliance with: <ul style="list-style-type: none">SAE J3043 (26 G)
Installation	Device Retained on Main Assembly with 2 Upper Arms with Red Quick Release Mechanisms and Lateral Blockers
Attachment Options	Anti-Rotation Micro Disc, Bottom Micro Disc
Transportation Compatibility System	Compatible with Technimount's Various Mounting Systems for Air and Ground Ambulances
Features	<ul style="list-style-type: none">Secures medical devices directly on stretcher for air and ground EMS and Critical Care TransportInstalls on the left or right side of the stretcherAccess to the medical device from all access (360° rotation)Red Quick Release Mechanism to easily insert and remove the bracketVertical and Horizontal Versions Available
Physical Overall Dimensions	Safety MD-Transporter® (Vertical) <ul style="list-style-type: none">Width 3.94 in (7.62 cm), Depth 3.4 in (10.16 cm), Height 15.96 in (38.1cm) (other heights available for ground and air ambulance installation - refer to Kits and Other Options in this user guide) Safety MD-Transporter® (Horizontal) <ul style="list-style-type: none">Width 3.94 in (7.62 cm), Depth 5.95 in (12.7 cm), Height 11.13 in (27.94 cm)
Weight (Standard Version)	3.3 lb (1.36kg) (weight differs slightly per height)
Maximum Weight Capacity	<ul style="list-style-type: none">540-00-OL13 - 25 lb when installed on the Stryker Stretcher540-00-OL13 - 40 lb when installed on an ambulance counter540-00-OL15-FL - 32 lb for the taller version with a height of 18.96 in and 3.6 lb
Part Numbers	<ul style="list-style-type: none">540-00-OL13 - Safety MD-Transporter® (Std Vertical) with Micro Base540-00-OL14 - Safety MD-Transporter® (Std Horizontal) with Micro BaseSee Kits and Other Options for all Part Numbers
Others Models and Configuration Options	Contact Technimount EMS for more information or for other options at customerservice@technimount.com

* Product and medical equipment manufacturer names are trademarks™ or registered trademarks™ of their respective holders. Technimount does not have a commercial relationship with these medical equipment manufacturers.

[Return To Table of Contents](#)

PURPOSE OF THE DOCUMENT

This User Guide is designed to assist you with the installation, operation and maintenance of the Safety MD-Transporter®.

PRODUCT DESCRIPTION

The Safety MD-Transporter® is a mounting system that consists of a Micro Base, mounted vertically (version 1) on a post, installed on Technimount's IV Pro Adapter® on another Micro Base on the side frame of the cot/stretchers. It is designed to support and transport portable medical devices with a maximum weight of twenty-five (25) lbs. in pre-hospital and hospital environments. The Safety MD-Transporter® can be removed and stored safely when not in use. When used in emergency vehicles with a cot/stretchers, the Safety MD-Transporter® rotates 360° for easy access to the medical device during transport and loading/unloading of the patient on the cot/stretchers.

The Safety MD-Transporter® is inserted into the Micro Base equipped with a locking mechanism and can accept any type of mounting bracket equipped with an Anti-Rotation Micro Disc on the back. The Safety MD-Transporter® is available for the right or the left side of the cot/stretchers. The IV Pro Adapter is required to install the Safety MD-Transporter®. Another version of the post (version 2) is also available with a horizontal Micro Base on the top to mount different equipment, according to the space available and other equipment installed around the mount.

INTENDED USE OF THE PRODUCT

The Safety MD-Transporter® is a secure mounting system for portable medical devices, designed to be installed on Stryker PowerPro™ cot/stretchers. The mount is intended to support and transport medical equipment during a medical intervention of a traumatized, an ambulatory or non-ambulatory patient (including infants, children and adults).

Once the Safety MD-Transporter® is installed, it facilitates the safe transport of smaller portable medical equipment (i.e. defibrillator and/or pumps) in emergency vehicles. The use of the Safety MD-Transporter® was designed to be used on an ambulance cot/stretchers and is intended for front-line responders who have received the training necessary to operate the system in the field. It's designed to work with other products on a cot/stretchers, such as the Safety Arm System. The Safety MD-Transporter® is intended for transport purposes only. It shouldn't carry more than one medical device. It is not intended for more than one unit or any additional equipment attached to the post.

The Safety MD-Transporter® is compatible only with Technimount's mounting solutions that have an Anti-Rotation Micro Disc on the back for version 1 or a Micro Disc on the bottom for version 2.

PRODUCT ILLUSTRATION

Safety MD-Transporter®
Vertical Micro Base Installed



Safety MD-Transporter® Post



Micro Disc at the
Base of the Safety
MD-Transporter®
Post Inserts into
the Horizontal
Micro Base on the
IV Pro Adapter



NOTICE

The Safety MD-Transporter® is designed to comply with the essential requirements and other relevant provisions of the Directive SAE J3043 and FAA, 14 CFR § 23 (applicable standards). Contact Customer Service (customerservice@technimount.com) for more information.

Technimount EMS Inc.

C/O: Regulatory Affairs
3770 Jean Marchand Street, Suite 100-C
Quebec (QC) G2C 1Y6
Canada
T + 1 581-700-6613
TF + 1 888.639.2758

technimount.com
info@technimount.com



WARNING

The end user and administrator are responsible to validate regulations and standards for safety in their region, in order to comply with applicable safety regulations. Technimount is not responsible to inform the end user and/or the administrator of applicable legislation for safety in their area.

REMOVING PACKAGING FOR INSTALLATION

1. Unpack boxes and check all items for proper operation.
2. Ensure that all shipping and packaging materials have been properly removed from the product(s) prior to installation.
3. Identify all of the product components and hardware prior to starting the installation.
4. Some hardware or parts provided might not be applicable to the model of your cot/stretchers.
5. The Safety MD-Transporter® must work properly before it is put into service.
6. Refer to the identification of components at the beginning of this user guide if needed.

NOTE

- ✓ Loose items or debris on the cot/stretchers can interfere with the operation of the Safety MD-Transporter® and cot/stretchers. Keep the cot/stretchers and the floor clear.

TOOLS REQUIRED FOR INSTALLATION

Below are the basic tools required for installation. Other tools may also be needed. If you have any questions regarding the installation, or need assistance, please contact our Technical Support team at techsupport@technimount.com

- ✓ Philips Screwdriver

NOTE

- ✓ Electrical tools are not recommended for screwing into the cot/stretchers frame, as there is a potential risk of damage to the threads.

SAFETY MD-TRANSPORTER INSTALLATION

INSTALLING THE MICRO BASE ON AN ADAPTER PLATE OR SURFACE

1. Five (5) 10-32 Alloy Steel screws are used to install the Micro Base onto the an Adapter plate or counter.

NOTE

The length of the screws will depend on plate or counter width for the installation of the Micro Base.

2. If installation is on another surface for which there are no pre-existing screw holes, use drawing at the end of this document to perfectly align screw holes for installation of the Micro Base.

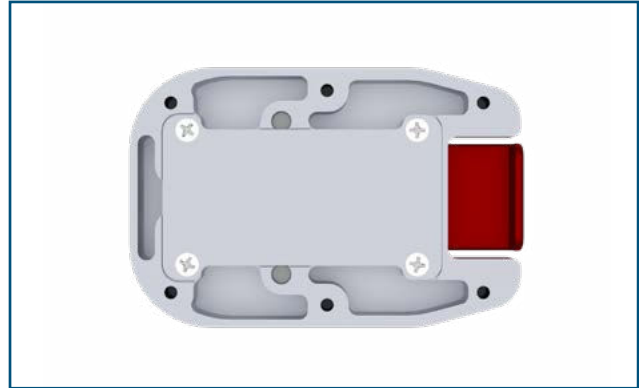

3. Refer to bolt pattern for installation of the Micro Base at the end of this user guide.
4. Align with the five (5) screw holes.

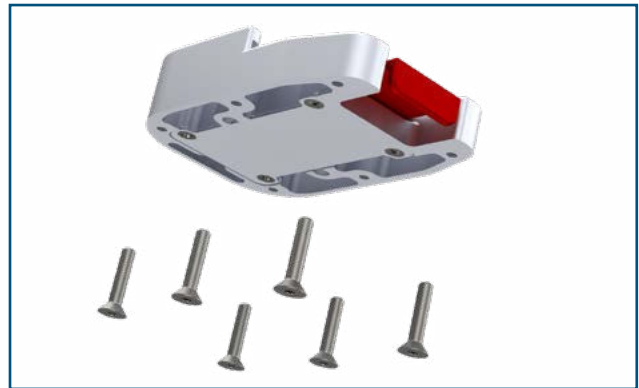

5. Add a drop of Loctite #243 to the screws before installation.
6. Insert screws.
7. Tighten all screws, while alternating screwheads.



INSTALLATION GUIDE

INSTALLATION OF THE SAEFTY MD-TRANSPORTER INTO A MICRO BASE

INSTALL SAFETY MD-TRANSPORTER INTO MICRO BASE

1. Slide the round base of the Safety MD-Transporter to secure it onto the Micro Base.



2. Safety MD-Transporter is installed in the Micro Base.

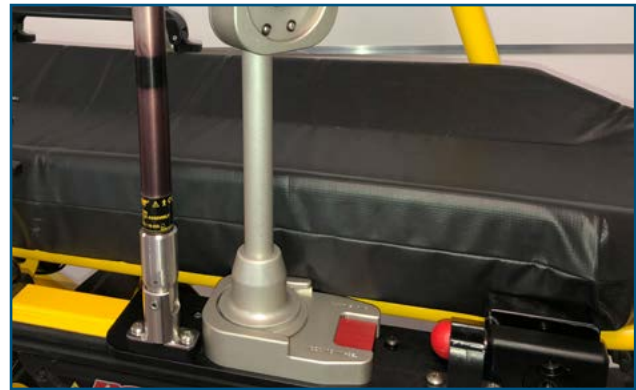

REMOVE THE SAFETY MD-TRANSPORTER

1. To remove the Safety MD-Transporter from the Micro Base, press and hold the Red Quick Release Mechanism and slide the Safety MD-Transporter outwards until completely removed from the base.



[Return To Table of Contents](#)

SUMMARY OF SAFETY PRECAUTIONS

WARNING/CAUTION/NOTE

Carefully read and strictly follow all Warnings and Cautions listed in this manual. Servicing and maintenance should only be done by qualified personnel.

WARNING

- ✓ To avoid injury, hands should be clear of the Micro Base while installing the medical equipment.
- ✓ Improper usage of the Safety MD-Transporter® can cause serious injury to the patient or operator. Operate only as described in this user guide.
- ✓ Do not modify the Safety MD-Transporter® or any components of the system. Modifying the product can cause unpredictable operation resulting in injury to the patient or operator.
- ✓ It is the responsibility of the operator to ensure that the Safety MD-Transporter® being used with Technimount products meets the installation specifications. Injury may result if non-compatible products are used with Technimount System products.
- ✓ Do not allow untrained staff to assist in the operation of the Safety MD-Transporter®. Untrained technicians/staff can cause injury to the patient or themselves.
- ✓ Do not sit or ride on the pole, damage to the product could occur, and may result in injury to the patient or operator.
- ✓ Grasping the Safety MD-Transporter® improperly can cause injury. Keep hands, fingers and feet away from moving parts.
- ✓ Operators must be able to safely lift the total weight of the Safety MD-Transporter® (post and medical device), and any items attached to the medical device.
- ✓ Do not attach restraints to the post, the Micro Base, or any other place of the system. It may result in damage to the system or equipment and/or result in injury to the patient or operator.
- ✓ Do not place any additional equipment or objects on the Safety MD-Transporter®, other than approved Technimount System device brackets for medical devices.
- ✓ Always avoid any improper pushing or violent manipulation, as it may result in injury to the patient or operator and/or damage to the product.
- ✓ To avoid the risk of patient injury or equipment damage, ensure that you properly mount and secure the medical device to the Micro Base.
- ✓ To avoid the risk of patient injury or equipment damage, you must ensure that the disc attached to the bracket under the medical device is properly locked into the Micro Base base.
- ✓ Improper maintenance can cause injury or damage to the product. Maintain the Safety MD-Transporter® as described in this user guide. Use only Technimount approved parts and maintenance procedures. Using unapproved parts and procedures could cause unpredictable operation and/or injury and will void the product warranty.
- ✓ Failure to properly clean or dispose of corrosive products will increase the risk of premature damage and may cause injury to the patient or operator.
- ✓ Do not adjust or remove the Safety MD-Transporter® while you are moving with the cot/stretchers.

SUMMARY OF SAFETY PRECAUTIONS

WARNING/CAUTION"NOTE (CONTINUED)

CAUTION

- ✓ Certified technical personnel familiar with the cot/stretchers specifications should complete the installation of the Safety MD-Transporter®. Refer to the cot/stretchers manufacturer's manual before installing the Safety MD-Transporter® and ensure that the installation does not damage or interfere with the use of the cot/stretchers.
- ✓ Inspect regularly the Safety MD-Transporter® and Micro Base for any issue and loose screws.

NOTE

- ✓ Some cleaning products are corrosive in nature and may cause damage to the product if used improperly. If such products are used to clean Technimount equipment, the equipment must be rinsed with clean water and thoroughly dried following the cleaning. Failure to properly rinse and dry the Safety MD-Transporter® will leave a corrosive residue on the surface, possibly causing premature corrosion of critical components.
- ✓ Installation of the Safety MD-Transporter® was designed to be placed on either side of the stretchers with the use of the **right** or the **left** Safety MD-Transporter® (patient right or left). When ordering, it is important to identify which side the Safety MD-Transporter® is to be located. The Safety MD-Transporter® cannot be reversed as the black metal plate (IV Pro Adapter plate) has been designed for a specific side.
- ✓ A preventive maintenance program should be established for all Technimount equipment. Preventive maintenance may need to be performed more frequently, based on the level of use of the product.
- ✓ Failure to use authorized parts, and lubricants, etc., could cause damage to the Safety MD-Transporter® and will void the warranty of the product.
- ✓ This user guide should be considered a permanent part of the Safety MD-Transporter® and should remain with the product.
- ✓ Technimount continually seeks advancements in product design and quality. Therefore, while this manual contains the most current product information available at the time of printing, there may be minor discrepancies between your Safety MD-Transporter® and this user guide.

If you have any questions, or for more information, please contact Technimount Customer Service at customerservice@technimount.com.

GENERAL OPERATING GUIDELINES

- ✓ Use the Safety MD-Transporter® only as described in this User Guide.
- ✓ Read all the labels and instructions on the product before using the Safety MD-Transporter®.
- ✓ Always inspect the Micro Base and the Safety MD-Transporter® for any issue or damage before every use.
- ✓ Installing or removing the Safety MD-Transporter® requires a minimum of one (1) trained operator.

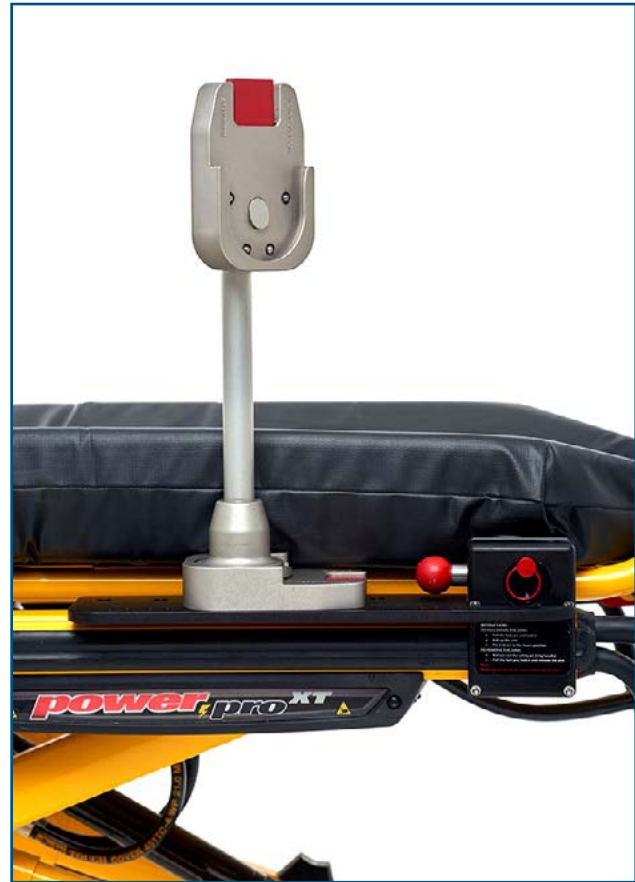

WARNING

- ✓ Never let a patient grab, manipulate or hold the Safety MD-Transporter®, or the Micro Base on the cot/stretcher because it may cause injury to the operator or patient. Secure the Safety MD-Transporter® as recommended while the patient is on the cot/stretcher.

OPERATING BRACKET WITH THE SAFETY MD-TRANSPORTER®

INSTALLING THE BRACKET ONTO THE SAFETY MD-TRANSPORTER®

1. Only Technimount brackets with an Anti-Rotation Micro Disc on the back can be inserted into the Micro Base located on the Safety MD-Transporter®.
2. Ensure that your bracket has an Anti-Rotation Micro Disc on the back to install the medical device onto the Safety MD-Transporter®.



3. While using both hands, slowly insert Anti-Rotation Micro Disc located on the back of the bracket into the Micro Base.

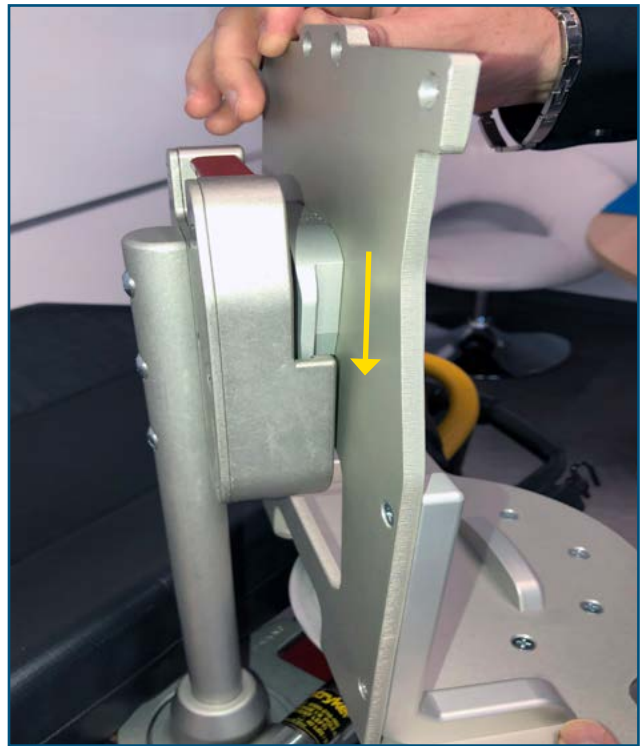

OPERATING THE SAFETY MD-TRANSPORTER® (CONTINUED)

INSTALLING THE BRACKET ONTO THE SAFETY MD-TRANSPORTER® (CONTINUED)

4. A Technimount bracket with an Anti-Rotation Micro Disc on the back installed on the Safety MD-Transporter®.



ROTATING THE BRACKET ON THE SAFETY MD-TRANSPORTER

1. To rotate the Safety MD-Transporter® with the medical device 360°, turn the Safety MD-Transporter® clockwise or counter clockwise.



OPERATING THE SAFETY MD-TRANSPORTER (CONTINUED)

REMOVING THE BRACKET FROM THE SAFETY MD-TRANSPORTER

1. To remove the bracket and medical device from the Safety MD-Transporter®, press the red quick release button located on the back Micro Base.
2. While holding the red quick release button, lift the bracket upwards in a straight line.

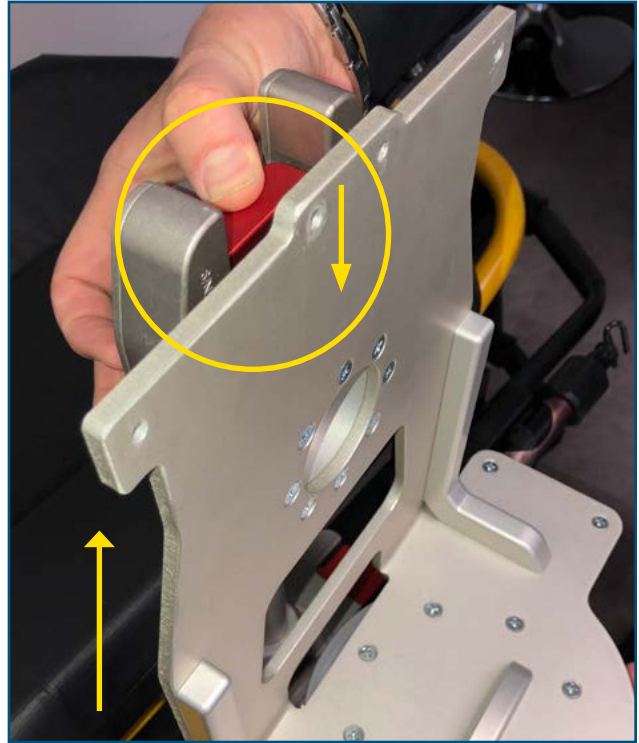

MOUNTING SYSTEM PART NUMBERS

KITS AND OTHER OPTIONS

Some exceptions may apply for the PowerPro Stretcher, please confirm with Customer Service at customerservice@technimount.com prior to placing your order.

SAFETY MD-TRANSPORTER WITH THE VERTICAL MICRO BASE

<u>DESCRIPTION</u>	<u>PART NUMBER</u>
The Safety MD Transporter Post (Standard)	540-10-OL13
The Safety MD Transporter Post (Air and Ground)	540-10-OL15-FL
Micro Base with Quick Release Mechanism (Ground)	120-20-UN
Micro Base with Quick Release Mechanism for (Air and Ground)	120-20-UN-510-FL

* For available kits, please contact Customer Service at customerservice@technimount.com.

SAFETY MD-TRANSPORTER WITH THE HORIZONTAL MICRO BASE - VERSION 2

<u>DESCRIPTION</u>	<u>PART NUMBER</u>
The Safety MD-Transporter® Post (Angled Post)	540-10-OL14-ANG
Micro Base with Quick Release Mechanism	120-20-UN

* For available kits, please contact Customer Service at customerservice@technimount.com.

CLEANING THE SAFETY MD-TRANSPORTER

CLEANING PROCESS

The Safety MD-Transporter® can be cleaned by using a pressure washer. The unit may show some signs of oxidation or discoloration from continuous washing, however, degradation of the cot's performance or functionality will not be affected due to power washing if cleaning instructions are properly followed.

The material used to manufacture the Safety MD-Transporter® is high-grade aluminum, it is very durable and resistant to corrosion, however high levels of sodium or a high concentration of sodium or acid may prematurely corrode the product. Always rinse with soft soap and water if exposed.

- ✓ Use of a power washer can accelerate removal of contaminants collected during the use of the product.
- ✓ Rinse with clean water.
- ✓ Towel dry all casters and interface points, inside the triangle head and clamp block.
- ✓ Allow all other components to air dry.
- ✓ Avoid over saturation and ensure that the product does not stay wet longer than the cleaner manufacturer's guidelines for proper disinfecting.



WARNING

- ✓ When cleaning, always use appropriate personal protection equipment (PPE) based on established protocols (e.g., gloves, eyewear, etc.).



CAUTION

- ✓ Do not steam clean or use ultrasonic cleaners on the system or any of its components.
- ✓ Do not immerse the metal parts/components in water.
- ✓ Maximum water temperature should not exceed 180°F/82°C
- ✓ Maximum water pressure should not exceed 1500 psi/103.5 BAR . If a pressure washer is being used to clean the unit, the pressure nozzle must be kept a minimum of 24 inches (61 cm) from the unit.

CLEANING SOLUTIONS

Phenolic type or quaternary type disinfectants can be used (excluding Virex® TB). Iodophor type disinfectants, Peracetic Acid, Chlorine, and especially Hydrogen Peroxide are not recommended for use because staining and corrosion may result.

Suggested cleaners for the Safety MD-Transporter® surfaces and clamp box:

- ✓ Quaternary Cleaners (active ingredient - ammonium chloride)
- ✓ Phenolic Cleaners (active ingredient - o-phenyl phenol)
- ✓ Chlorinated Bleach Solution (3.25% - less than 1-part bleach to 100 parts water)

CLEANING THE SAFETY MD-TRANSPORTER (CONTINUED)

CLEANING SOLUTIONS (CONTINUED)

WARNING

- ✓ Some cleaning products are corrosive in nature and may cause damage to the product if used improperly.
- ✓ If the products described above are used to clean the equipment, the Safety MD-Transporter® must be rinsed with clean water and thoroughly dried following cleaning. Failure to properly rinse and dry the Safety MD-Transporter® will leave a corrosive residue on the surface of the product, possibly causing premature corrosion of critical components.

REMOVAL OF IODINE COMPOUNDS

Use a solution of 1/4 Tablespoon of Sodium Thiosulfate in 1 pint / .5 litre of warm water to clean the stained area. Clean as soon as possible after staining occurs. If stains are not immediately removed, allow solution to soak or stand on the surface. Thoroughly rinse surfaces with clean water and allow to air dry before returning unit to service.

WARNING

- ✓ Failure to properly clean contaminated parts or components will increase the risk of exposure to blood borne pathogens and may cause injury to the patient or the operator.

PREVENTIVE MAINTENANCE

A preventive and regular maintenance program should be established for all Technimount equipment. Preventive maintenance may be required more frequently based on the usage level of the product. The Safety MD-Transporter® requires regular preventive maintenance. Establish and follow a preventive maintenance schedule and keep records of preventive maintenance activities.

CAUTION

- ✓ Close attention should be given to safety features including, but not limited to both Micro Bases, Anti-Rotation Micro Disc, and post.
- ✓ Improper maintenance can cause injury or damage to the product. Maintain the product as described in this user guide.

LUBRICATION

The Safety MD-Transporter® has been designed to operate without the need for lubrication. Due to an anodization of the metallic parts, using a silicone-base lubricant can be used but it is not necessary. If you're not sure about the product to use, please contact technical support or customer service.

CAUTION

- ✓ Failure to use authorized parts, lubricants, etc. could cause damage to the cot/stretcher and will void the warranty of the product.

MAINTENANCE GUIDE

INSPECTION PROCESS AND SCHEDULE

PREVENTIVE MAINTENANCE PROGRAM

The following inspection routine and schedule is intended as a general guide for preventive maintenance of the Safety MD-Transporter®. Factors such as weather, environment, geographical location, and individual usage will necessitate different maintenance. If you are unsure as to how to perform these maintenance inspections or at what interval to perform these inspections, please contact your Technical Support Team at techsupport@technimount.com. Check each routine and replace damaged or worn out parts if necessary.

Follow table below in accordance to the timetable, whichever comes first.

<u>ITEM</u>	<u>ROUTINE</u>	<u>1 M</u> <u>OR</u> <u>2 H</u>	<u>3 M</u> <u>OR</u> <u>6 H</u>	<u>6 M</u> <u>OR</u> <u>12 H</u>	<u>12 M</u> <u>OR</u> <u>24 H</u>
Micro Base	<ul style="list-style-type: none"> ✓ Inspect Mechanism ✓ Inspect Red Quick Release Mechanism ✓ Inspect General Functionalities 	X			
Safety MD-Transporter	<ul style="list-style-type: none"> ✓ Inspect Screws that hold the Micro Base ✓ Inspect the General Condition of the Base of the Post ✓ Inspect the Assembly of the Post ✓ Ensure There are no Loose Parts 	X			

MAINTENANCE GUIDE

REPLACEMENT PARTS

The parts and accessories listed are all currently available for purchase. Some of the parts identified on the assembly drawing parts in this user guide may not be individually available for purchase. Please call Technimount Customer Service or Technical Support : +1.581-998-9820 or at customerservice@technimount.com or techsupport@technimount.com for availability and pricing.

AFETY MD-TRANSPORTER WITH THE VERTICAL MICRO BASE - VERSION 1

<u>DESCRIPTION</u>	<u>PART NUMBER</u>
The Safety MD Transporter Post (Standard)	540-10-OL13
The Safety MD Transporter Post (Air and Ground)	540-10-OL15-FL
Micro Base with Quick Release Mechanism (Ground)	120-20-UN
Micro Base with Quick Release Mechanism for (Air and Ground)	120-20-UN-510-FL

* For available kits, please contact Customer Service at customerservice@technimount.com.

SAFETY MD-TRANSPORTER WITH THE HORIZONTAL MICRO BASE - VERSION 2

<u>DESCRIPTION</u>	<u>PART NUMBER</u>
The Safety MD-Transporter® Post (Angled Post)	540-10-OL14-ANG
Micro Base with Quick Release Mechanism	120-20-UN

WARRANTY POLICY

This statement constitutes TECHNIMOUNT's entire warranty policy with regards to the TECHNIMOUNT Products.

TECHNIMOUNT MAKES NO OTHER WARRANTY OR REPRESENTATION NEITHER EXPRESSED NOR IMPLIED, EXCEPT AS SET FORTH HEREIN. THERE IS NO WARRANTY OF MERCHANTABILITY AND THERE ARE NO WARRANTIES OF FITNESS FOR ANY PARTICULAR PURPOSE. IN NO EVENT SHALL TECHNIMOUNT BE LIABLE HEREUNDER FOR INCIDENTAL OR CONSEQUENTIAL DAMAGES ARISING FROM OR IN ANY MANNER RELATED TO SALES OR USE OF ANY SUCH EQUIPMENT.

TECHNIMOUNT E.M.S. Holding Inc. (TECHNIMOUNT) guarantees to the original "Purchaser" of the "Hardware" with which this "Limited Warranty" is included that the Hardware will be free from "Defects" in workmanship and materials under normal use for a "Warranty Period", one (1) year from the date that the Hardware was first purchased by the Purchaser. During the Warranty Period, the Hardware will be repaired or replaced according to the "Limited Warranty" without charge to the Purchaser for either parts or labor. The parts may be repaired or replaced with either new or refurbished parts. The product may be replaced for a new or refurbished product. For this Limited Warranty "refurbished" means parts and products, which have been returned to factory specifications. If the Hardware is repaired or replaced within the Warranty Period, the greater of the remaining warranty period will apply or three (3) months from the date of repair/replacement. If the Hardware is repaired or replaced after the Warranty Period has expired, the Warranty Period for the repair or replacement will expire three (3) months after the date of repair or replacement.

LIMITED RESPONSIBILITY AND WARRANTY

The Limited Warranty does not apply to normal wear that should result from normal use. It does not apply when the Hardware or any component is opened, disassembled, or repaired by someone not authorized by TECHNIMOUNT and does not cover repair or replacement of any Hardware or part thereof damaged by neglect, misuse, moisture, liquids, exposure to heat, accidents, abuse, and non-compliance with the instructions for installation and use provided with the Hardware. The Limited Warranty does not cover physical damage to the surface of the Hardware, and the decision to repair, replace or refuse the coverage is final and its sole discretion of TECHNIMOUNT, and is made without any compensation or obligation from TECHNIMOUNT.

The hardware, or product defined as a mounting or bracket system for clipping and attaching medical equipment is specifically designed to fill this requirement. Any other use will void the warranty and TECHNIMOUNT will not be held liable on any claim if the product is modified or adapted for use.

Technimount products are intended to retain a medical device in place in the case of a single crash impact. A Technimount product must NOT be used again if it was involved in a crash. The product MUST be replaced. If the Purchaser uses a Technimount product following a crash, it is at the Purchaser's own risk and Technimount will not be held liable.

INTERNATIONAL WARRANTY CLAUSE

This warranty reflects Canadian domestic policy. Warranty outside Canada may vary by country. Please contact TECHNIMOUNT Customer Service for more information.

RETURN POLICY

Mounting systems and bracket systems for portable medical devices may be returned up to 60 days of receipt if:

- The product is not what was originally ordered
- The product does not meet specifications with TECHNIMOUNT's technical sheets according to the customers
- The product is not compatible with the equipment on which it was to be installed

For any manufacturing defect, refer to the conditions of the Warranty Policy.

PRIOR TO 30 DAYS

- Product must be undamaged and in its original packaging
- The product return request must be provided in writing and it must be approved by TECHNIMOUNT prior to returning the product
- Returns will not be approved on a modified or damaged item
- Charges may apply if damaged or missing item
- Customer is responsible for a 10% restocking fee

PRIOR TO 45 DAYS

- Product must be unused, undamaged and in its original packaging
- The product return request must be provided in writing and it must be approved by TECHNIMOUNT SYSTEM prior to returning the product
- Returns will not be approved on modified or damaged item
- Charges may apply if damaged or missing items
- Customer is responsible for a 25% restocking fee

PRIOR TO 60 DAYS

- Product must be unused, undamaged and in its original packaging
- The product return request must be provided in writing and it must be approved by TECHNIMOUNT prior to returning the product
- Returns will not be approved on a modified or damaged item
- Charges may apply if damaged or missing items
- Customer is responsible for a 30% restocking fee

RETURN AUTHORIZATION

TECHNIMOUNT's customer service department is responsible for approving any merchandise return and will provide a Return Merchandise Authorization (RMA) number to be printed on any returned merchandise. TECHNIMOUNT reserves the right to charge shipping and restocking fees on returned items. SPECIAL, MODIFIED, OR DISCONTINUED ITEMS NOT SUBJECT TO RETURN.

DAMAGED MERCHANDISE

ICC Regulations require that claims for damaged merchandise must be made with the carrier within fifteen (15) days of receiving merchandise. DO NOT ACCEPT DAMAGED SHIPMENTS UNLESS SUCH DAMAGE IS NOTED ON THE DELIVERY RECEIPT AT THE TIME OF RECEIPT. Upon prompt notification, TECHNIMOUNT will file a freight claim with the appropriate carrier for damages incurred. Claim will be limited in amount to the actual replacement cost. In the event that this information is not received by TECHNIMOUNT within the fifteen (15) day period following the delivery of the merchandise, or the damage was not noted on the delivery receipt at the time of receipt, the customer will be responsible for payment of the original invoice in full.

Note: Claims for any short or broken shipment must be made within thirty (30) days of invoice.

CLAIM PROCESS

Please follow the claim procedure below to return a defective product:

Fill in the RMA form online at <https://www.technimount.com/service-support/service-support-overview/>

REQUIRED INFORMATION

- Serial number
- Invoice number
- Identification of the issue
- Upload the pictures of the issue
- Submit the form

A confirmation of the receipt of the claim will be sent to you within 2 business days. If you have not received a confirmation Email by then, please contact techsupport@technimount.com.

If the RMA request is approved, TECHNIMOUNT will provide you with an RMA number for your claim. We will also include instructions for the replacement of your product. No product return will be accepted without the RMA number labeled on the outside of the box being returned.

FINDINGS AND CONCLUSION

- If following an investigation, we find that our product is defective, TECHNIMOUNT will take corrective actions and close the claim
- If following an investigation, we find that our product is NOT defective (misuse or abuse of the product) the product will not be covered by the warranty. Details of our findings and conclusions will be provided to you.

QUESTIONS ABOUT OUR POLICY

If you have any questions regarding our return policy, please contact our Customer Service department at customerservice@technimount.com.

BOLT PATTERN

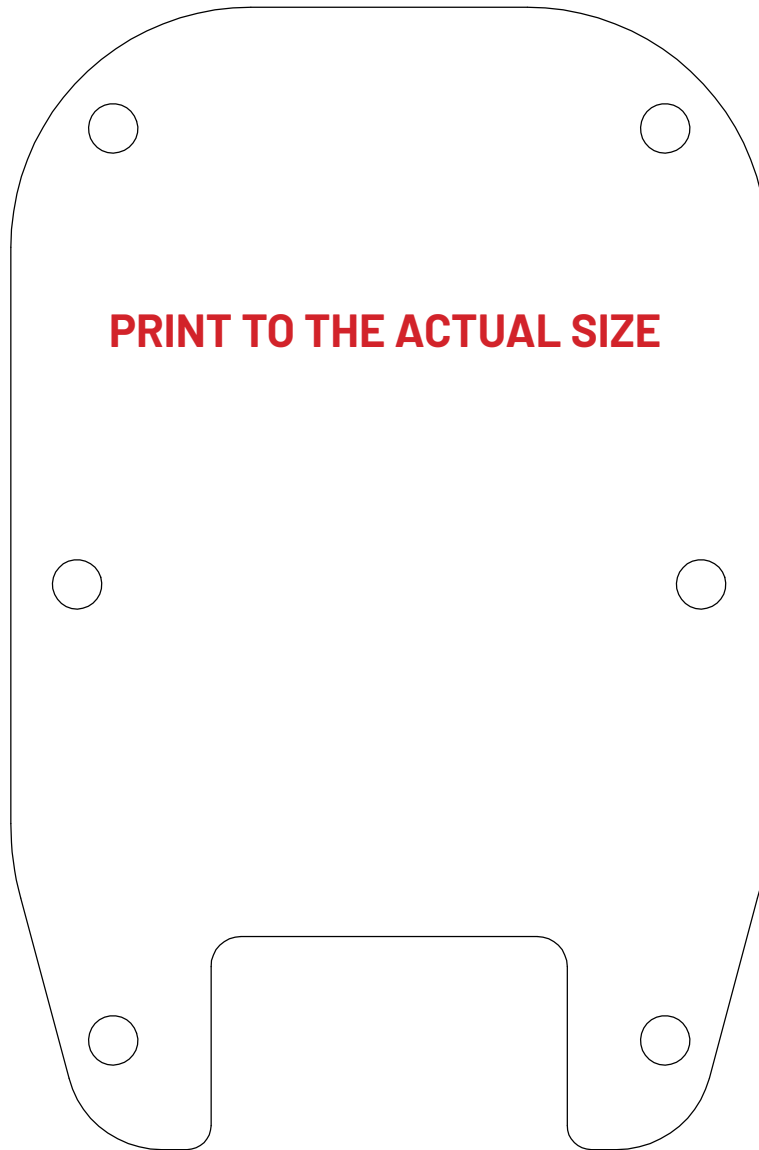

DIMENSIONS

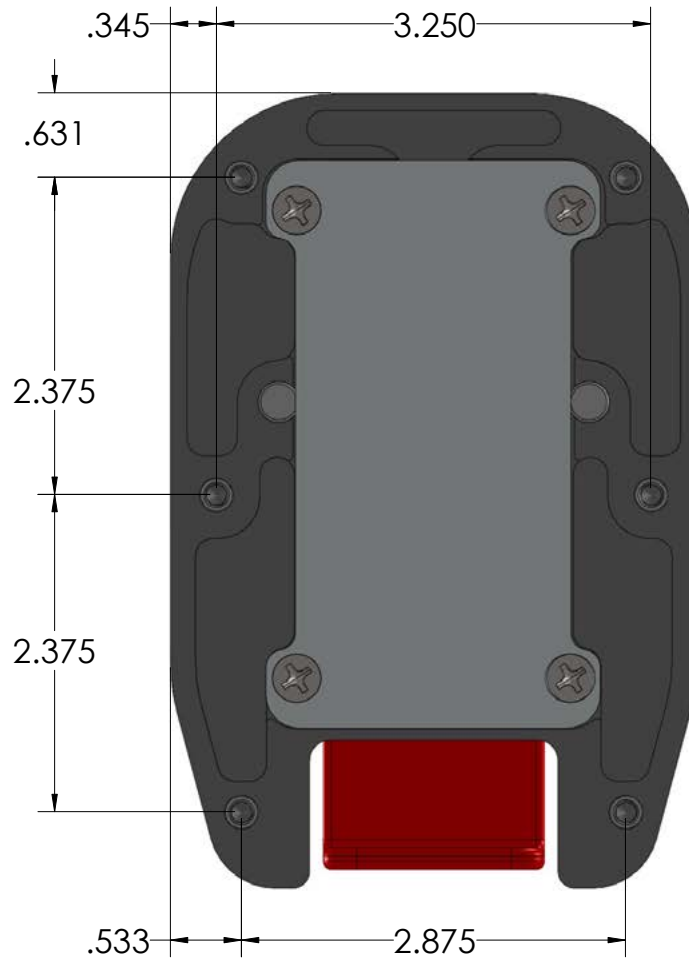

SAE CERTIFICATION



SAFETY AND FLEXIBILITY WHERE IT MATTERS MOST

TECHNIMOUNT E.M.S. HOLDING INC.
3770 Jean Marchand Street, Suite 100-C
Quebec (QC) G2C 1Y6
Canada
T + 1 581.700.6613
TF +1 888.639.2758
technimount.com
info@technimount.com

© 2022 Technimount E.M.S. Holding Inc. - All Rights Reserved
Printed in Canada



SMDT UG 202206-01