



TECHNIMOUNT
SYSTEM™

BRACKET PRO SERIE® 110

USER GUIDE



COPYRIGHT

Copyright Technimount System, Subsidiary of Technologies CGC Inc. 2019. All Rights Reserved. No part of this publication may be reproduced, transmitted, transcribed, stored in a retrieval system, or translated into any language in any form or by any means without the written permission of Technimount System or its affiliate companies.

Trademark Attributions

Bracket Pro Serie® is a registered trademark of Technimount System.

Monnal T60® is a registered trademark from Air Liquide.

Technimount System does not have a commercial relationship with Air Liquide. Air Liquide does not promote or sell Technimount Products.

In order to ensure continuous improvements to our products and services, we invite you to communicate your comments to our Customer Service Department at customerservice@technimount.com. See Contact Information.

CONTACT INFORMATION

CORPORATE HEADQUARTERS

TECHNIMOUNT SYSTEM

Customer Service or Technical Support
3770 Jean Marchand Street, Suite 100
Quebec (QC) G2C 1Y6
Canada

www.technimount.com

T + 1 581.998.9820

F + 1 855.339.6351

or

customerservice@technimount.com

techsupport@technimount.com

NOTE:

Please have the serial number of your Technimount product available (as shown in the figure below) when calling Technimount Customer Service or Technical Support. Include the serial number in all written communications.

SERIAL NUMBER LOCATION



[Return To Table of Contents](#)

TABLE OF CONTENTS

COPYRIGHT	2
CONTACT INFORMATION.....	3
INTRODUCTION	6
PRODUCT DESCRIPTION	6
INTENDED USE OF THE PRODUCT	6
POSSIBLE MOUNTING OPTIONS FOR THE BRACKET PRO SERIE® 110.....	7
SYMBOLS AND DEFINITIONS	8
WARNING / CAUTION / NOTE.....	9
PRODUCT ILLUSTRATION.....	10
<i>BRACKET PRO SERIE® 110</i>	10
<i>FRONT VIEW</i>	10
<i>BACK VIEW</i>	11
.....	12
NOTICE	13
SUMMARY OF SAFETY PRECAUTIONS	14
WARNING/CAUTION/NOTE	14
INSTALLATION GUIDE	16
REMOVING THE PACKAGING FOR INSTALLATION.....	16
USING THE BACK HOOKS.....	21
OPERATION GUIDE	22
GENERAL OPERATING GUIDELINES FOR THE SAFETY MD TRANSPORTER	22
OPERATING THE BRACKET ON THE SAFETY MD TRANSPORTER	23
<i>INSTALLING THE BRACKET ONTO THE SAFETY MD TRANSPORTER</i>	23
<i>ROTATING THE BRACKET ON THE SAFETY MD TRANSPORTER</i>	24
<i>REMOVING THE BRACKET WITH THE MEDICAL DEVICE FROM THE SAFETY MD TRANSPORTER</i>	25
GENERAL OPERATING GUIDELINES FOR THE SAFETY ARM SYSTEM	26
OPERATING THE BRACKET ON THE SAFETY ARM SYSTEM	27
<i>INSTALLING THE BRACKET ON THE STANDARD BASE</i>	27
<i>ROTATING THE BRACKET ON THE STANDARD SURFACE BASE</i>	27
<i>REMOVING THE BRACKET FROM THE STANDARD SURFACE BASE</i>	28
<i>USING THE BACK HOOKS ON THE STRETCHER OR HOSPITAL BED</i>	28
PART NUMBERS	29
KITS AND OTHER OPTIONS	29
MAINTENANCE GUIDE.....	30
CLEANING THE BRACKET SYSTEM	30
<i>CLEANING PROCESS</i>	30
<i>CLEANING SOLUTIONS</i>	30
<i>REMOVAL OF IODINE COMPOUNDS</i>	31
PREVENTIVE MAINTENANCE.....	31
<i>LUBRICATION</i>	31
INSPECTION PROCESS AND SCHEDULE.....	32
<i>MAINTENANCE PROGRAM</i>	32
INSPECTION AND MAINTENANCE RECORD.....	33
TRAINING RECORD.....	34
REPLACEMENT PARTS.....	35
WARRANTY	36

TABLE OF CONTENTS

WARRANTY POLICY	36
WARRANTY OPTIONS	37
<i>THREE WARRANTY OPTIONS FOR TECHNIMOUNT PRODUCTS</i>	37
INTERNATIONAL WARRANTY CLAUSE	37
RETURN POLICY	38
RETURN OF MERCHANDISE	38
<i>PRIOR TO 30 DAYS</i>	38
<i>PRIOR TO 45 DAYS</i>	38
<i>PRIOR TO 60 DAYS</i>	38
<i>RETURN MERCHANDISE AUTHORIZATION</i>	38
<i>DAMAGED MERCHANDISE</i>	38
SAE CERTIFICATION	39

INTRODUCTION

This User Guide is designed to assist you with the installation, operation and maintenance of the Technimount Bracket Pro Serie 110 for the Monnal T-60 Ventilator. Please read this User Guide thoroughly before using this equipment. To ensure the safe operation of this equipment, it is recommended to train staff prior to use.

PRODUCT DESCRIPTION

The Bracket Pro Serie® Mounting System is the only universal solution to mount the Monnal T60 ventilator from Air Liquide in different applications such as, on surface, floor, cot/stretcher and wall systems. It can fit any ground and air ambulance configurations in North American and European markets. It is designed to securely support and transport the Monnal T60 ventilator in pre-hospital and hospital environments. When used in emergency vehicles with a cot/stretcher, the Bracket Pro Serie® 110 can be positioned on Technimount's Safety Arm System, on a universal standard base, on a Safety MD Transporter or with Technimount's Floor Mount or Wall Mount Systems. These solutions provide a higher flexibility for different EMS/CCT protocols and applications.

The Bracket Pro Serie® 110 is compatible with the floor platform of air ambulances in Europe. It can also be used with the wall mount for ground ambulances in Europe and North America. This mounting system is compatible with all of Technimount's products.

INTENDED USE OF THE PRODUCT

The Bracket Pro Serie® 110 is a mounting solution to securely transport the Monnal T60 ventilator from Air Liquide during intra and inter-hospital transport. It is designed to be installed on the equipment as described in this user guide. This equipment is for crew who has received the appropriate training necessary to operate the equipment in the field according to its intended use as outlined in this user guide.

INTRODUCTION

POSSIBLE MOUNTING OPTIONS FOR THE BRACKET PRO SERIE® 110

Safety MD Transporter



Wall Mount System
(Ground Ambulance in Europe)

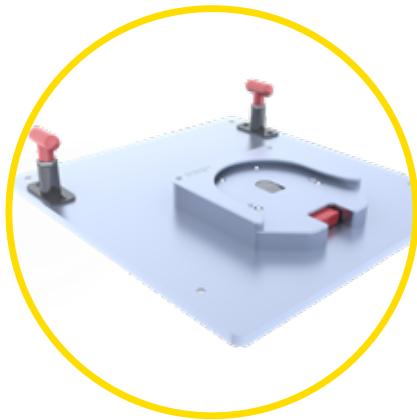
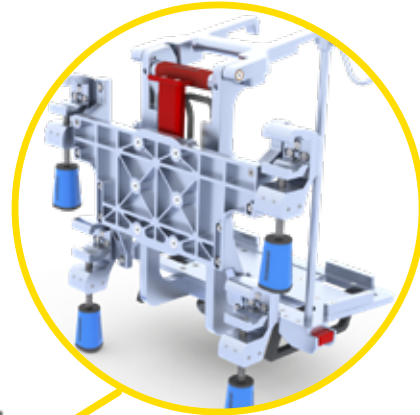

Air Ambulance
Floor Mount







Technimount
Stretcher Safety
Arm System

Technimount
Universal Standard
Base





SYMBOLS AND DEFINITIONS

<u>SYMBOL</u>	<u>DESCRIPTION</u>
	Caution, special attention is required. Consult accompanying documents
	Safe working load symbol
	Pinch Point
	Load balance symbol

WARNING / CAUTION / NOTE

The word warning, caution, or note carry special meaning and should be carefully reviewed.

<u>SYMBOL</u>	<u>DESCRIPTION</u>
	<p>WARNING</p> <p>Alerts the reader about a situation which, if not avoided, could result in death or serious injury. It may also describe potential serious adverse reactions and safety hazards.</p>
	<p>CAUTION</p> <p>Alerts the reader of a potentially hazardous situation, which, if not avoided, may result in minor or moderate injury to the user or patient or damage to the equipment or other property. This includes special care necessary for the safe and effective use of the device to avoid damage that may occur as a result of use or misuse.</p>
<p>NOTE</p>	<p>Provides special information about the product.</p>

INTRODUCTION

PRODUCT ILLUSTRATION

[BRACKET PRO SERIE® 110](#)

[Front View](#)

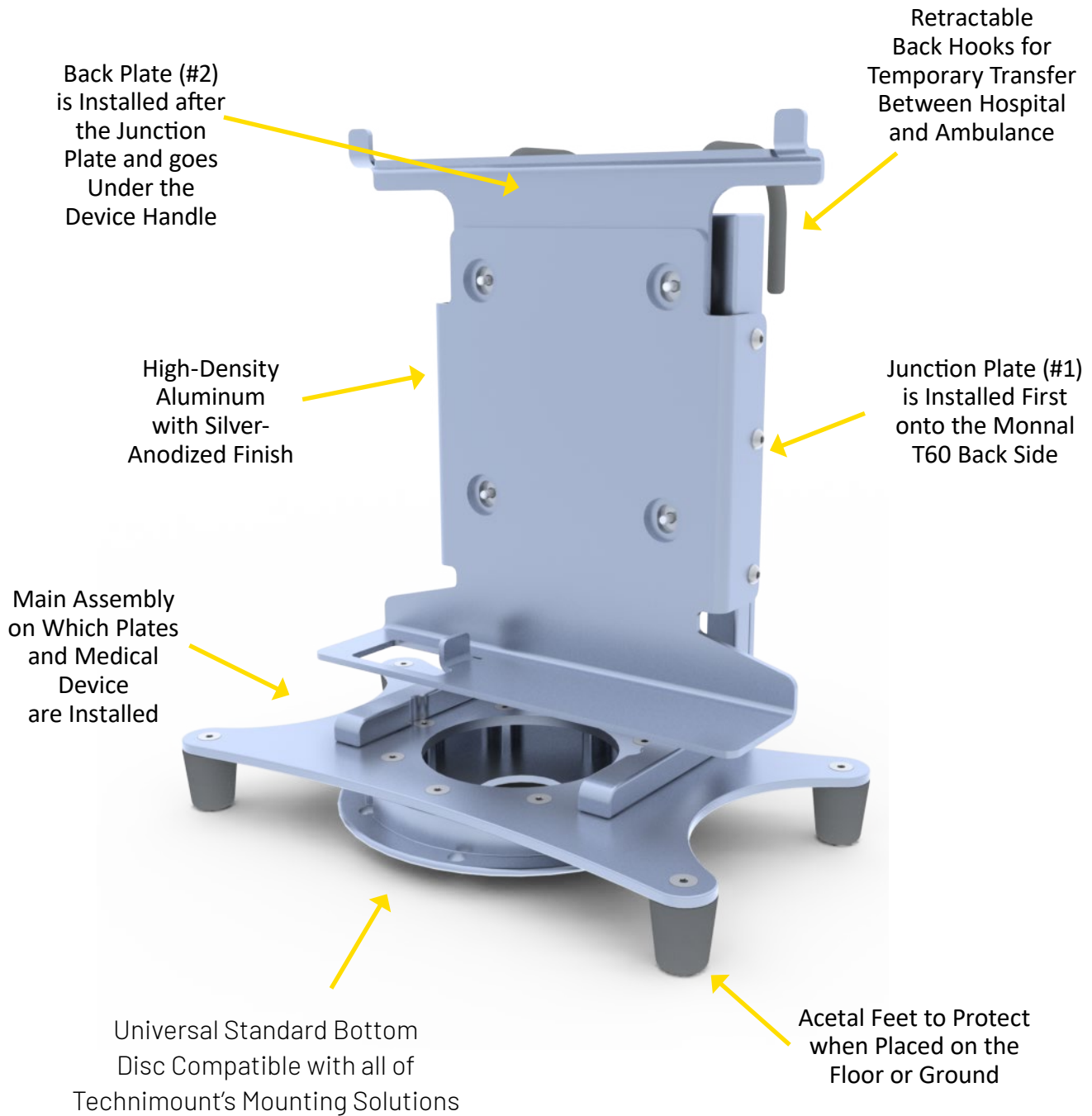

INTRODUCTION

PRODUCT ILLUSTRATION (CONTINUED)

BRACKET PRO SERIE ® 110 (CONTINUED)

Back View

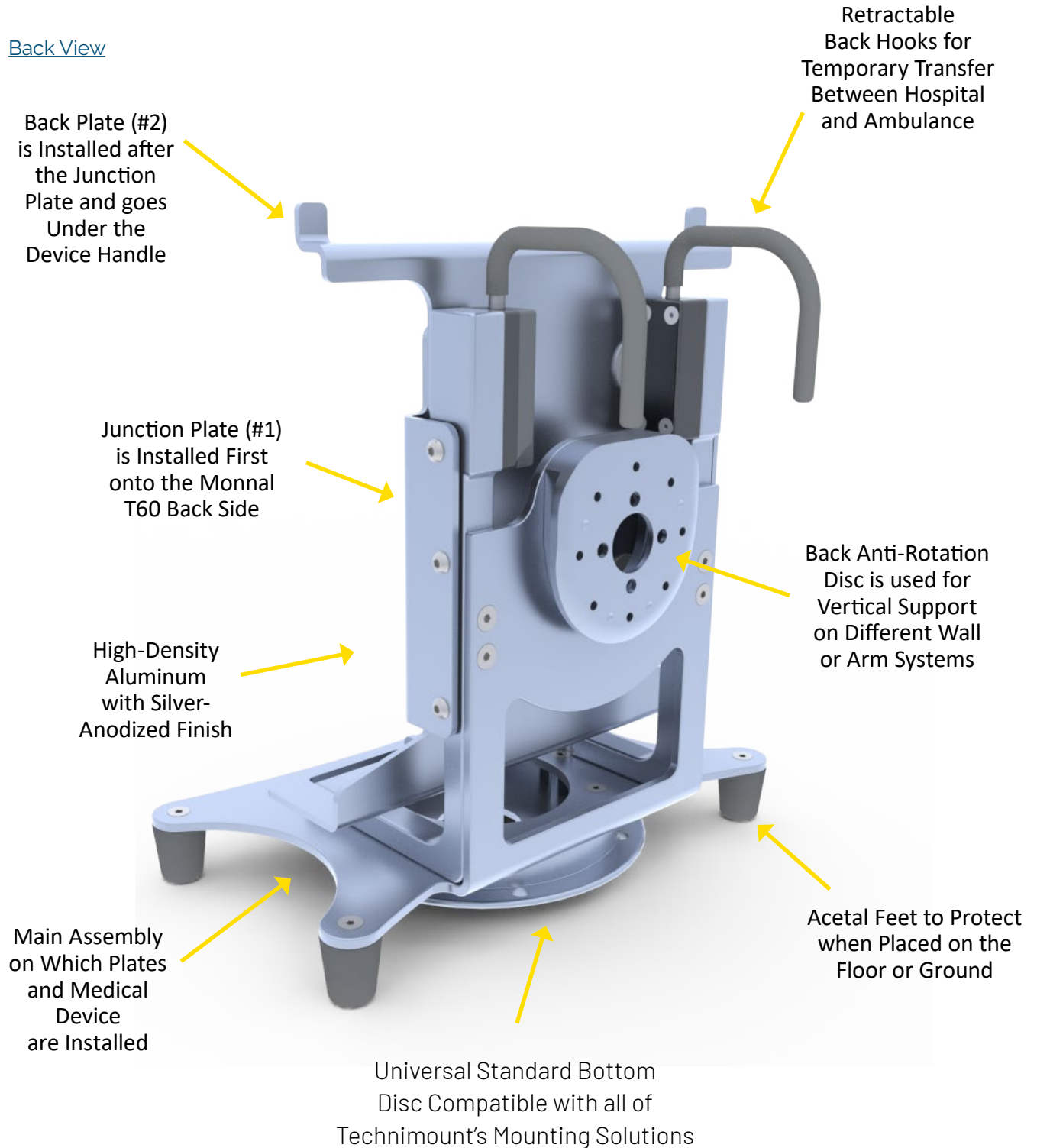

[Return To Table of Contents](#)

INTRODUCTION

Product Name	Bracket Pro Serie® 110
Compatibility of Medical Device	Monnal T60 Ventilator from Air Liquide
Environment of Usage	EMS (Ground & Flight) – Hospital/Clinic, Military
Device Section Material	High-Density Aluminum with Gray Anodized Finish – Acetal Feet
Bottom Disc Section Material	Aluminum with Stainless Steel Insert and Peek Cushions
Anti-Rotation Back Disc Material	High-Density Aluminum with Gray-Anodized Finish
Temperature of Usage	- 35° C @ 45° C (Direct Conduction)
Impact Resistance – Ground - USA	SAE J3043 (30 G) Plus 10% Safety Factor
Impact Resistance – Ground – EU	DIN EN 1789 (10 G)
Impact Resistance - Flight	FAA – FAR -DOT 27.561 & DOT 27.562 up to 20G
Medical Device Retaining System	Device Retained on Platform with Junction and Back Plates
Retaining System	2 Locking Discs – Standard Bottom Section – Anti-Rotation Back Micro Disc
Transportation Compatibility System	<ul style="list-style-type: none"> • Compatible with Technimount’s Standard Surface Base • Compatible with Technimount’s Stretcher Safety Arm System For Stryker Cots (PowerPro – XT and Mx-Pro) • Compatible with the Floor Mount Platform (Flight) • Compatible with Wall Mount System (Micro Base System) • Compatible with the Safety MD Transporter
Features	<ul style="list-style-type: none"> • Robust Mounting Solution for EMS/CCT/ALS Transport • Access to all Connectors and Accessories • Retractable hooks for Temporary Transport Between Hospital and Ambulance • Fits with the Carrying Case System without Modification
Physical Overall Dimensions	Length 10.81 in., Width 6.94 in., Height 12.07 in.
Weight (Bracket Only)	Bracket Only – 5.79 lbs Bracket with Device - 14.6 lbs
Part Number	Bracket without Back Hooks - 1300-10-MT Bracket with the Back Hooks - 1300-11-MTBH

INTRODUCTION

NOTICE

The Bracket Pro Serie® 110 Mounting System is designed to comply with SAE J3043.

Technimount hereby declares that the Bracket Pro Serie® 110 Mounting System is in compliance with the essential requirements and other relevant provisions of the Directive 1999/5/EC and SAE J3043. A copy of the original declaration of conformity can be obtained by contacting Technimount System's Regulatory Affairs Department:

Technimount System

C/O: Regulatory Affairs
info@technimount.com
+ 1 581.998.9820



End User/Administrator is responsible to validate regulations and standards for safety in their region, in order to comply with applicable safety regulations. Technimount System is not responsible to inform the End User/Administrator of applicable legislation for safety in their area.

SUMMARY OF SAFETY PRECAUTIONS

WARNING/CAUTION/NOTE

Carefully read and strictly follow all Warnings and Cautions listed in this user guide. Servicing and maintenance should only be done by qualified personnel.

WARNING

- ✓ Always hold the Bracket with both hands when you manipulate it.
- ✓ Operate the bracket only as described in this user guide.
- ✓ Do not modify the Bracket, or any components of Technimount systems. Modifying the product can cause unpredictable operation resulting in injury to the patient or operator.
- ✓ It is the responsibility of the operator of the Bracket or any of its options, to ensure equipment being used with the Technimount products meets the installation specifications. Injury may result if non-compatible products are used with Technimount System products.
- ✓ Do not attempt to operate, install or remove the equipment while mobile. Ensure that installation and removal of equipment is done while vehicle or aircraft is immobilized.
- ✓ Verify that the bracket is inserted correctly into a mounting system and locked with whichever disc is used (standard bottom disc or back anti-rotation disc). If equipment is improperly installed and locked, it can cause the equipment to fall and cause injury to the patient or operator and/or damage to the medical equipment.
- ✓ Never use the Bracket if not properly installed and locked on a Surface Base, Safety Arm System on a cot/stretchers, on a Wall Mount or Floor Mount. If not installed properly, the medical device could fall during transport and may cause injury to the patient or operator and/or damage to the product.
- ✓ Do not allow untrained staff to assist in the operation of the mounting system. Untrained technicians/staff can cause injury to the patient or themselves.
- ✓ Do not place additional equipment or items onto the Bracket or mounts other than approved Technimount Systems or components, as this could damage the product and may result in injury to the patient or operator.
- ✓ Operators must be able to safely lift the total weight of the Bracket System and Medical Device.
- ✓ Do not attach restraints to the Bracket frame. It may result in damage to the System and/or result in injury to the patient or operator.
- ✓ Always reposition the equipment with care, avoid any improper pushing or violent manipulation, as it may result in unbalanced equipment and may cause injury to the patient or operator and/or damage to the product.
- ✓ Improper maintenance can cause injury to patient or operator or damage to the product. Maintain the Bracket and Mounting Systems as described in this user guide. Use only Technimount approved parts and maintenance procedures. Using unapproved parts and procedures could cause unpredictable operation and/or injury and will void the product warranty.
- ✓ Failure to properly clean or dispose of corrosive products will increase the risk of premature damage and may cause injury to the patient or operator.
- ✓ Any installation on a surface, wall or on the structure of the vehicle or the aircraft has to be validated or inspected in order to ensure it maintains the integrity of the vehicle or the aircraft.

SUMMARY OF SAFETY PRECAUTIONS

WARNING/CAUTION/NOTE (CONTINUED)



CAUTION

- ✓ Only certified technical personnel familiar with the Bracket installation and use should manipulate it. Always refer to Technimount's user guides for all instructions for installing and using any Technimount Mounting System.
- ✓ Inspect regularly all components on the equipment for any issue and loose screws, bolts and nuts.
- ✓ Never install the mount into or on other similar mounting systems or brackets without written confirmation by Technimount System as these different systems may be from other brands or models and may not be compatible with Technimount Systems.

NOTE

- ✓ Some cleaning products are corrosive in nature and may cause damage to the product if used improperly. If such products are used to clean Technimount equipment, the equipment must be rinsed with clean water and thoroughly dried following the cleaning. Failure to properly rinse and dry the Mounting Systems will leave a corrosive residue on the surface, possibly causing premature corrosion of critical components.
- ✓ When ordering, it is important to identify on which mounting system you need to mount the bracket on as their are different systems for different EMS applications, e.g., EMS ground or air mounting systems.
- ✓ A maintenance program should be established for all Technimount equipment. Preventive maintenance may need to be performed more frequently, based on the level of use of the product. Close attention should be given to safety features (i.e.: screws, quick release mechanisms, and attachment points).
- ✓ Failure to use authorized parts, and lubricants, etc., could cause damage to the equipment and will void the warranty of the product.
- ✓ This user guide should be considered a permanent part of the Bracket, and should remain with the product even if the equipment is subsequently sold.
- ✓ Technimount continually seeks advancements in product design and quality. Therefore, while this user guide contains the most current product information available at the time of printing, there may contain minor differences between your mounting system and this user guide. If you have any questions, please contact Technimount Customer Service or Technical Support at +1.581.998.9820.

INSTALLATION GUIDE

REMOVING THE PACKAGING FOR INSTALLATION

1. Unpack boxes and check all items.
2. Ensure that all shipping and packaging materials have been properly removed from the product(s) prior to installation.
3. Identify all of the product components and hardware prior to starting the installation.
4. The Bracket System must work properly before being put into service.
5. Refer to the identification of components at the beginning of this user guide if needed.

TOOLS REQUIRED FOR INSTALLATION

Below are the basic tools required for installation. If you have any questions regarding the installation, or need assistance, please contact our Technical Support team at techsupport@technimount.com

1. Allen Key 1/8 in.
2. Allen Key 4mm



NOTE

- ✓ Electrical tools are not recommended, as there is a potential risk of damage to the threads.
- ✓ Technimount System provides screws with scotchgrip for the installation of the Back Plates and main assembly.



FIGURE 1. 4 WASHERS AND 4 HEXAGONAL SCREWS TO ASSEMBLE BOTH BACK PLATES TO MEDICAL DEVICE



FIGURE 2. 6 HEXAGONAL SCREWS TO INSTALL MEDICAL DEVICE ONTO THE MAIN ASSEMBLY

INSTALLATION OF THE BRACKET ONTO THE MONNAL VENTILATOR

1. The Bracket Pro Serie[®] 110 is designed to be installed on the Monnal T60 ventilator including its bag.

 **WARNING**

- ✓ This particular version of the bracket cannot be used without the bag.



2. Remove the Bag.



3. Locate the plastic cover with the hooks on the back of the unit.
4. The cover, and metal plate with hooks will be replaced with Technimount's bracket and hooks.
5. Remove plastic cover from the back of the unit by unscrewing all 4 screws.

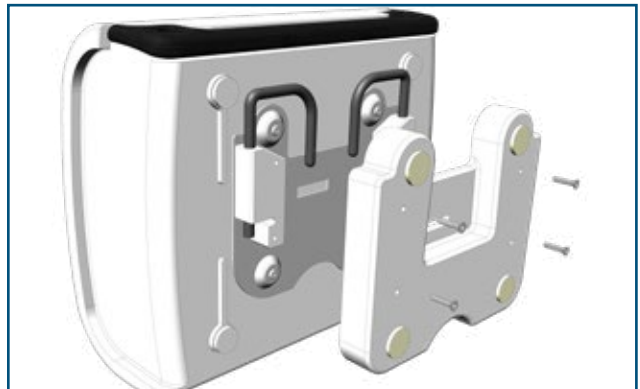

INSTALLATION GUIDE

INSTALLATION OF THE BRACKET ONTO THE MONNAL VENTILATOR (CONTINUED)

6. Locate the 4 screws on the back metal plate.
7. Remove the back plate with hooks by removing all 4 screws.

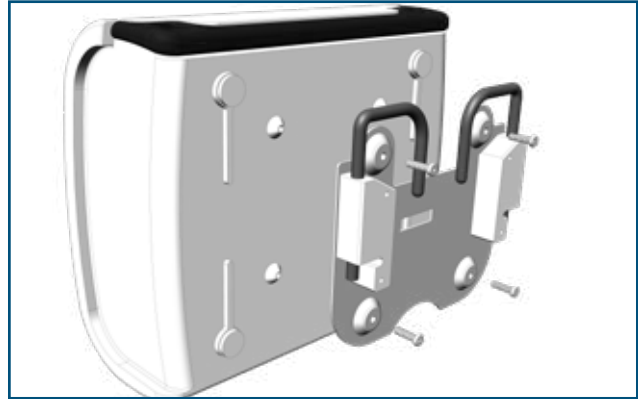

8. Remove the metal plate with hooks completely
9. Set aside the cover and back metal plate for use without the mounting bracket.

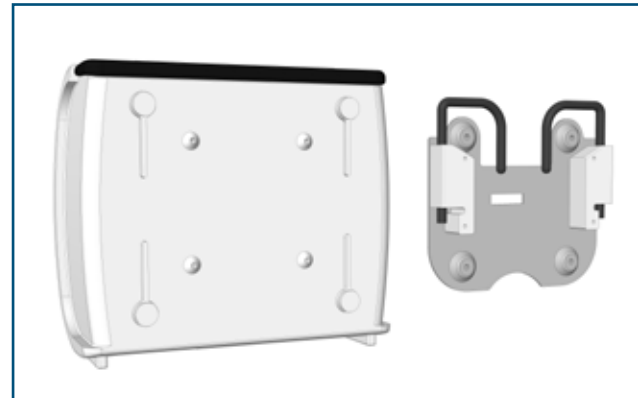

10. Place both Junction Plate #1 and Back Plate onto the back of the Monnal T60 ventilator.



INSTALLATION GUIDE

INSTALLATION OF THE BRACKET ONTO THE MONNAL VENTILATOR (CONTINUED)

11. Start by placing the Junction Plate first onto the Back of the Monnal T60 ventilator.



12. Lift the top handle of the ventilator.
13. Place the Back Plate onto the Junction Plate next and ensure it is placed under the handle.



14. Put handle back down over top of the Back Plate.
15. Place washers over the 4 holes.
16. Insert all 4 screws provided for the installation of the back plates.



INSTALLATION OF THE BRACKET ONTO THE MONNAL VENTILATOR (CONTINUED)

17. Replace the bag back onto the Monnal T60 ventilator with back plates installed.



18. The device is now ready to be installed onto the main assembly.



19. There are 3 screws to be installed on each side of the back plates onto the main assembly.
20. Ensure to adjust all 6 screws before tightening.
21. Tighten all 6 screws while alternating screwsheads.



INSTALLATION OF THE BRACKET ONTO THE MONNAL VENTILATOR (CONTINUED)

22. The unit is now ready for EMS transport.



CAUTION

- ✓ Always use Technimount Brackets with compatible and approved mounting systems and products by Technimount.



USING THE BACK HOOKS

1. To open the hooks, open one hook at a time by pulling the hook towards you.
2. To close the hooks, close one hook at a time by pushing the hook back into closed position.

WARNING

The Bracket Pro Serie® 110 Back Hooks are meant to be used only for the temporary transfer between the ambulance stretcher and hospital. These hooks CANNOT be used to mount inside the ambulance during EMS transport.



GENERAL OPERATING GUIDELINES FOR THE SAFETY MD TRANSPORTER

- ✓ Use the Safety MD Transporter only as described in the User Guide.
- ✓ Read all the labels and instructions on the product before using the Safety MD Transporter.
- ✓ Always inspect the Micro Base and the Safety MD Transporter for any issue or damage before every use.
- ✓ Installing or removing the Safety MD Transporter requires a minimum of one (1) trained operator.
- ✓ Do not remove the Safety MD Transporter while moving with the cot/stretchers.
- ✓ Stay with the patient and control the Safety MD Transporter at all times.



WARNING

- ✓ Never let a patient grab, manipulate or hold the Safety MD Transporter, or the Micro Base on the cot/stretchers because it may cause injury to the operator or patient. Secure the Safety MD Transporter as recommended while the patient is on the cot/stretchers.

OPERATING THE BRACKET ON THE SAFETY MD TRANSPORTER

INSTALLING THE BRACKET ONTO THE SAFETY MD TRANSPORTER

1. Only Technimount brackets with an anti-rotation micro disc on the back can be inserted into the Micro Base located on the Safety MD Transporter.
2. Ensure that your bracket has an anti-rotation micro disc on the back to install the medical device onto the Safety MD Transporter.



3. While using both hands, slowly insert anti-rotation disc located on the back of the bracket into the Micro Base.

WARNING

- ✓ Ensure that the bracket is securely locked into the micro base before transport.



OPERATION GUIDE

OPERATING THE BRACKET ON THE SAFETY MD TRANSPORTER (CONTINUED)

INSTALLING THE BRACKET ONTO THE SAFETY MD TRANSPORTER (CONTINUED)

4. A Bracket Pro Serie 110 installed on the Safety MD Transporter.



ROTATING THE BRACKET ON THE SAFETY MD TRANSPORTER

1. To rotate the medical device 360°, turn the Safety MD Transporter clockwise or counter clockwise.

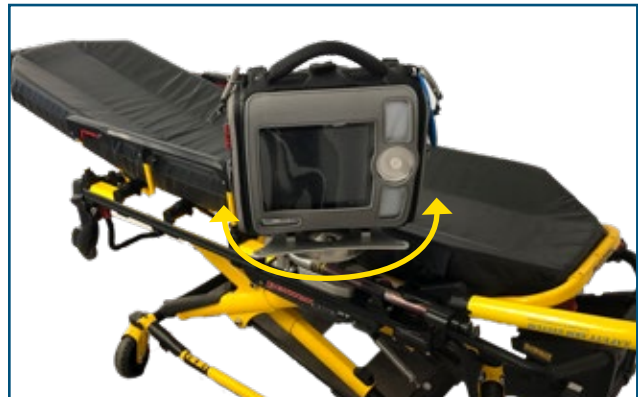

OPERATING THE BRACKET ON THE SAFETY MD TRANSPORTER (CONTINUED)

REMOVING THE BRACKET WITH THE MEDICAL DEVICE FROM THE SAFETY MD TRANSPORTER

1. To remove the bracket from the Safety MD Transporter, press the red quick release button located on the back Micro Base.
2. While holding the red quick release button, lift the bracket upwards until removed and release the red quick release button.



GENERAL OPERATING GUIDELINES FOR THE SAFETY ARM SYSTEM

- ✓ Use the Safety Arm System only as described in its User Guide.
- ✓ Read all the labels and instructions on the product before using the Safety Arm System.
- ✓ Always inspect the Clamp Block, Safety Pin, Lock Pin, and Surface Base before every use.
- ✓ Installing or removing the Safety Arm System requires a minimum of one (1) trained operator.
- ✓ Do not remove the Safety Arm System or device from the system while moving with the cot/stretcher.
- ✓ Stay with the patient and control the Safety Arm System and device during transport at all times.

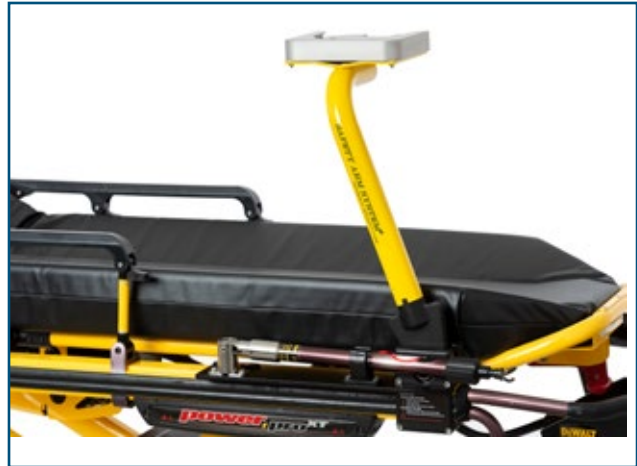

WARNING

- ✓ Never let a patient grab, manipulate or hold the Safety Arm System, the Surface Base or bracket on the cot/stretcher because it may cause injury to the operator or patient. Secure the Safety Arm System and bracket as recommended while the patient is on the cot/stretcher.

OPERATING THE BRACKET ON THE SAFETY ARM SYSTEM

INSTALLING THE BRACKET ON THE STANDARD BASE

1. Only Technimount brackets with an standard bottom disc can be inserted into the surface Base located on the Safety Arm.
2. To insert the bracket into the standard surface base, slide into the base horizontally from the front of the base.
3. Ensure the bracket is locked securely in the Standard Surface base before manipulating the device or transporting the stretcher.



ROTATING THE BRACKET ON THE STANDARD SURFACE BASE

1. To rotate the medical device 360°, turn the bracket inside the standard surface base clockwise or counter clockwise to use the device in the desired position.



OPERATING THE BRACKET ON THE SAFETY ARM SYSTEM (CONTINUED)

REMOVING THE BRACKET FROM THE STANDARD SURFACE BASE

1. To remove the bracket from the Safety MD Transporter, press the red quick release button located on the back Standard Base.
2. While holding the red quick release button, slide outwards horizontally to remove from the base.



USING THE BACK HOOKS ON THE STRETCHER OR HOSPITAL BED

1. Open back hooks one at a time by pulling towards you.
2. Place onto the side rail of the stretcher or hospital bed.



WARNING

The Bracket Pro Serie® 110 Back Hooks are meant to be used only for the temporary transfer between the ambulance stretcher and hospital. These hooks CANNOT be used to mount inside the ambulance during EMS transport.



PART NUMBERS

KITS AND OTHER OPTIONS

<u>DESCRIPTION</u>	<u>PART NUMBER</u>
Bracket Only	552-10-AB-BR
Wall Mount Only	553-20-AB-WA
Floor Mount Only	554-20-AB-FL
Unviersal Standard Base	100-20-UN
Safety Arm System	Several Models Available, refer to Customer Service
Safety MD Transporter	Different Models Available, refer to Customer Service

 **WARNING**

Do not modify any components of these system. Modifying the products can cause unpredictable operation resulting in injury to the patient or operator.

NOTE

Technimount reserves the right to change Part Numbers and Products without notice. Please refer to Customer Service to ensure product part number availability.

For any replacement parts or for repair, please contact Technical Support at techsupport@technimount.com

CLEANING THE BRACKET SYSTEM

CLEANING PROCESS

The Bracket can be cleaned by using a pressure washer. The bracket may show some signs of oxidation or discoloration from continuous washing, however, degradation of the cot/stretchers performance or functionality will not be affected due to power washing if cleaning instructions are properly followed.

The material used to manufacture the Bracket is high-grade aluminum, it is very durable and resistant to corrosion, however high levels of sodium or a high concentration of sodium or acid may prematurely corrode the product. Always rinse with soft soap and water if exposed.

- ✓ Use of a power washer can accelerate removal of contaminants collected during the use of the product.
- ✓ Rinse with clean water.
- ✓ Towel dry all components.
- ✓ Allow all other components to air dry.
- ✓ Avoid over saturation and ensure that the product does not stay wet longer than the cleaner manufacturer's guidelines for proper disinfecting.



WARNING

- ✓ When cleaning, always use appropriate personal protection equipment (PPE) based on established protocols (e.g., gloves, eyewear, etc.).



CAUTION

- ✓ Do not steam clean or use ultrasonic cleaners on the system or any of its components.
- ✓ Do not immerse the metal parts/components in water.
- ✓ Maximum water temperature should not exceed 180°F/82°C.
- ✓ Maximum water pressure should not exceed 1500 psi/103.5 BAR . If a pressure washer is being used to clean the unit, the pressure nozzle must be kept a minimum of 24 inches (61 cm) from the unit.

CLEANING SOLUTIONS

Phenolic type or quaternary type disinfectants can be used (excluding Virex® TB). Iodophor type disinfectants, Peracetic Acid, Chlorine, and especially Peroxide Oxygen are not recommended for use because staining and corrosion may result.

Suggested cleaners for the Bracket:

- ✓ Quaternary Cleaners (active ingredient - ammonium chloride)
- ✓ Phenolic Cleaners (active ingredient - o-phenyl phenol)
- ✓ Chlorinated Bleach Solution (3.25% - less than 1-part bleach to 100 parts water)

CLEANING THE BRACKET SYSTEM (CONTINUED)

CLEANING SOLUTIONS CONTINUED

WARNING

- ✓ Some cleaning products are corrosive in nature and may cause damage to the product if used improperly.
- ✓ If the products described are used to clean the equipment, the Bracket and components must be rinsed with clean water and thoroughly dried following cleaning. Failure to properly rinse and dry the system will leave a corrosive residue on the surface of the product, possibly causing premature corrosion of critical components.

REMOVAL OF IODINE COMPOUNDS

Use a solution of 1/4 Tablespoon of Sodium Thiosulfate in 1 pint / .5 litre of warm water to clean the stained area. Clean as soon as possible after staining occurs. If stains are not immediately removed, allow solution to soak or stand on the surface. Thoroughly rinse surfaces with clean water and allow to air dry before returning unit to service.

WARNING

- ✓ Failure to properly clean contaminated parts or components will increase the risk of exposure to blood borne pathogens and may cause injury to the patient or the operator.

PREVENTIVE MAINTENANCE

A preventive and regular maintenance program should be established for all Technimount equipment. Preventive maintenance may be required more frequently based on the usage level of the product. The Bracket requires regular preventative maintenance. Establish and follow a preventive maintenance schedule and keep records of preventive maintenance activities (see maintenance form in this user guide).

CAUTION

- ✓ Close attention should be given to safety features including, but not limited to locking mechanisms and Discs.
- ✓ Improper maintenance can cause injury or damage to the product. Maintain the product as described in this user guide.

LUBRICATION

The Bracket System has been designed to operate without the need for lubrication. If you have questions, please contact Technical Support at techsupport@technimount.com.

CAUTION

- ✓ Failure to use authorized parts, lubricants, etc. could cause damage to the cot/stretchers and will void the warranty of the product.

MAINTENANCE GUIDE

INSPECTION PROCESS AND SCHEDULE

MAINTENANCE PROGRAM

The following inspection routine and schedule is intended as a general guide for preventive maintenance of the Bracket. Factors such as weather, environment, geographical location, and individual usage will necessitate different maintenance. If you are unsure as to how to perform these maintenance inspections or at what interval to perform these inspections, please contact your Technical Support Team at techsupport@technimount.com. Check each routine and replace damaged or worn out parts if necessary.

Follow table below in accordance to the timetable, whichever comes first.

<u>ITEM</u>	<u>ROUTINE</u>	<u>1 M</u> <u>OR</u> <u>2 H</u>	<u>3 M</u> <u>OR</u> <u>6 H</u>	<u>6 M</u> <u>OR</u> <u>12 H</u>	<u>12 M</u> <u>OR</u> <u>24 H</u>
Bracket	<ul style="list-style-type: none"> ✓ Inspect Bracket <ul style="list-style-type: none"> ▪ Inspect the screws ▪ Ensure it is working properly and there are no particles, obstacles, or debris ▪ Inspect side screws ✓ Verify Both Discs ✓ Do a visual inspection for the Bracket to ensure there is no damage or chemical attack 	X			

MAINTENANCE GUIDE

INSPECTION AND MAINTENANCE RECORD

<u>PREVENTIVE MAINTENANCE PERFORMED</u>	<u>BY</u>	<u>DATE</u>	<u>TIME</u>

MAINTENANCE GUIDE

TRAINING RECORD

<u>TRAINEE NAME</u>	<u>TRAINING DATE</u>		<u>TRAINING METHOD</u> <u>USER GUIDE,</u> <u>IN-SERVICE,</u> <u>IN-CLASS,</u> <u>ETC.</u>
	<u>BASIC TRAINING</u>	<u>TRAINING UPDATE</u>	

REPLACEMENT PARTS

The parts and accessories listed are all currently available for purchase. Some of the parts identified on the assembly drawing parts in this user guide may not be individually available for purchase. Please call Technimount Customer Service or Technical Support : +1.581-998-9820 or at customerservice@technimount.com or techsupport@technimount.com for availability and pricing.

<u>DESCRIPTION</u>	<u>PART NUMBER</u>
Anti-Rotation Back Disc	TCM-052-006
Standard Bottom Disc	926-00-SS
Acetal Feet	TCM-032-082
Label – Brand Name	942-00-UN
Label – Instructions in English	960-00-EN
Label – Instructions in French	960-00-FR

WARRANTY POLICY

Technimount guarantees to the original purchaser that the Bracket Pro Serie® 110 will be free from structural defects for one year as long as the original purchaser owns the product. Technimount's obligation under this one- year (1) limited warranty is limited to supplying replacement parts and labor for any component or option of this system that is found to be defective, at Technimount's sole discretion.

Upon Technimount's request, purchaser shall return to Technimount's shipping warehouse any product or part (freight prepaid by Technimount) for which an original purchaser makes a warranty claim. An RMA Number (Return Material Authorization Number) is required to send any hardware back to the factory. Please contact Technical support for assistance, techsupport@technimount.com



WARNING

Any improper use, alteration or repair by unauthorized service providers shall void this warranty.

This statement constitutes Technimount's entire warranty with respect to the aforementioned equipment.

Technimount System makes no other warranty or representation either expressed or implied, except as set forth herein. There is no warranty of merchantability and there are no warranties of fitness for any particular purpose. In no event shall Technimount be liable hereunder for incidental or consequential damages arising from or in any manner related to sales or use of any such equipment.

Technimount System guarantees to the original Purchaser of the Hardware with which this Limited Warranty is included, that the Hardware will be free from Defects in workmanship and material under normal use for a period of one (1) year from the date that the Bracket was first purchased, which is defined as the Warranty Period. During the Warranty Period, the Hardware will be repaired or replaced according to the Limited Warranty without charge to the purchaser for either parts or labor. The parts may be repaired or replaced with either new or refurbished parts. The product may be replaced for a new or refurbished product. For this Limited Warranty, refurbished means parts and products which have been returned to factory specifications. If the Hardware is repaired or replaced within the Warranty Period, the greater of the remaining warranty period will apply or three (3) months from the date of repair/ replacement. If the Hardware is repaired or replaced after the Warranty Period has expired, the Warranty Period for the repair or replacement will expire three (3) months after the date of repair or replacement.

LIMITED RESPONSIBILITY AND WARRANTY

Technimount System shall not be responsible for damage to the part or products resulting from improper installation or use, abuse, neglect, accident, servicing or any modification to any part of a Technimount product by anyone other than Technimount System or an organization certified by Technimount. Please always refer to the product's User Guide for the proper installation and use of the product.

The Limited Warranty does not apply to normal wear that should result from normal use. It does not apply when the hardware or any component is opened, disassembled, or repaired by someone not authorized by Technimount and does not cover repair or replacement of any Hardware or part thereof damaged by: neglect, misuse, moisture, liquids, exposure to heat, accidents, abuse, and non-compliance with the instructions for installation and use supplied with the Hardware. The Limited Warranty does not cover physical damage to the surface of the Hardware.

The hardware or product defined in this user guide as a mounting or bracket system for clipping and attaching medical equipment are specifically designed to fill this requirement. Any other use will void the warranty and Technimount will not be held liable for, or on any form of a claim if the product is modified or adapted for use.

WARRANTY OPTIONS

THREE WARRANTY OPTIONS FOR TECHNIMOUNT PRODUCTS

1. One-year (1) additional warranty after the original warranty has expired for parts and labor has terminated. Technimount guarantees to the original purchaser that its products should be free from manufacturing nonconformities that affect product performance and customer satisfaction for a period of one (1) year following the end date of the original warranty. Technimount's obligation under this warranty is limited to supplying replacement parts and labor for, or replacing for any product or option, that is found to be defective, at Technimount's sole discretion.
2. Two-year (2) additional warranty after the original warranty for parts and labor has terminated. Technimount guarantees to the original purchaser that its products should be free from manufacturing -nonconformities that affect product performance and customer satisfaction for a period of two (2) years following the end date of the original warranty. Technimount's obligation under this warranty is limited to supplying replacement parts and labor for any component or option of this system that is, found to be defective at Technimount's sole discretion.
3. Three- year (3) additional warranty after the original warranty for parts and labor has terminated. Technimount guarantees to the original purchaser that its products should be free from manufacturing nonconformities that affect product performance and customer satisfaction for a period of three (3) years following the end date of the original warranty. Technimount's obligation under this warranty is limited to supplying replacement parts and labor for any component or option of this system that is found to be defective, at Technimount's sole discretion.

INTERNATIONAL WARRANTY CLAUSE

This warranty reflects Canadian domestic policy. Warranty outside Canada may vary by country. Please contact your local Technimount representative for additional information.

RETURN POLICY

RETURN OF MERCHANDISE

The parts and/or components may be returned up to 60 days of receiving the product(s) if they meet the following guidelines:

PRIOR TO 30 DAYS

- ✓ 30-day money back guarantee in effect
- ✓ Technimount is responsible for all charges
- ✓ Returns will not be approved on modified item

PRIOR TO 45 DAYS

- ✓ Product must be unused, undamaged and in the original packaging
- ✓ Customer is responsible for a 20% restocking fee
- ✓ Reasons of returning the product must be provided in writing
- ✓ Returns will not be approved on modified or damaged item

PRIOR TO 60 DAYS

- ✓ Product must be unused, undamaged and in the original packaging
- ✓ Customer is responsible for a 30% restocking fee
- ✓ Reasons for returning the product must be provided in writing
- ✓ Returns will not be approved on modified or damaged item

RETURN MERCHANDISE AUTHORIZATION

Technimount's customer service department is responsible for approving any merchandise return and will provide an RMA (Return Merchandise Authorization) number to be printed on any returned merchandise. Technimount reserves the right to charge shipping and restocking fees on returned items. Customized, modified, or discontinued items not subject to return.

DAMAGED MERCHANDISE

ICC Regulations require that claims for damaged merchandise must be made with the carrier within fifteen (15) days of receiving merchandise. Do not accept damaged shipments unless such damage is noted on the delivery receipt at the time of receipt. Upon prompt notification, Technimount will file a freight claim with the appropriate carrier for damages incurred. Claim will be limited in amount to the actual replacement cost. In the event that this information is not received by Technimount within the fifteen (15) day period following the delivery of the merchandise, or the damage was not noted on the delivery receipt at the time of receipt, the customer will be responsible for payment of the original invoice in full.

NOTE

Claims for any short shipment must be made within thirty (30) days of invoice.

SAE CERTIFICATION



SAFETY AND FLEXIBILITY WHERE IT MATTERS MOST

TECHNIMOUNT SYSTEM - BRAND OF TECHNOLOGIES CGC

Corporate Headquarters

3770 Jean Marchand Street, Suite 100

Quebec (QC) G2C 1Y6

Canada

T + 1 581.998.9820

F + 1 855.339.6351

technimount.com

info@technimount.com

© Copyright 2020 Technimount System All Rights Reserved

Printed in Canada



TECHNIMOUNT
SYSTEM™