



TECHNIMOUNT
SYSTEM™

SAFETY MD TRANSPORTER®

USER GUIDE



COPYRIGHT

Copyright Technimount System, Brand of Technologies CGC Inc. 2019. All Rights Reserved. No part of this publication may be reproduced, transmitted, transcribed, stored in a retrieval system, or translated into any language in any form or by any means without the written permission of Technimount System or its affiliate companies.

Trademark Attributions

Safety MD Transporter is a registered trademark of Technimount System under the reference #100128-0005

The Safety MD Transporter is patented, under reference # 62/909-408

Stryker® stretcher models and numbers are registered trademarks from Stryker. Technimount System does not have a commercial relationship with Stryker. Stryker does not promote or sell Technimount Products.

In order to ensure continuous improvements to our products and services, we invite you to communicate your comments to our Customer Service Department at customerservice@technimount.com. See Contact Information.

CONTACT INFORMATION

CORPORATE HEADQUARTERS

TECHNIMOUNT SYSTEM

BRAND OF TECHNOLOGIES CGC

3770 Jean Marchand Street, Suite 100

Quebec (QC) G2C 1Y6

Canada

T + 1 581.998.9820

F + 1 855.339.6351

technimount.com

info@technimount.com

CUSTOMER SERVICE AND TECHNICAL SUPPORT

customerservice@technimount.com

techsupport@technimount.com

PRODUCT SERIAL NUMBER

Please have the serial number of your Technimount product available (as shown in the figure below) when calling Technimount Customer Service or Technical Support. Include the serial number in all written communications.

SERIAL NUMBER LOCATION ON THE SAFETY MD TRANSPORTER® POST

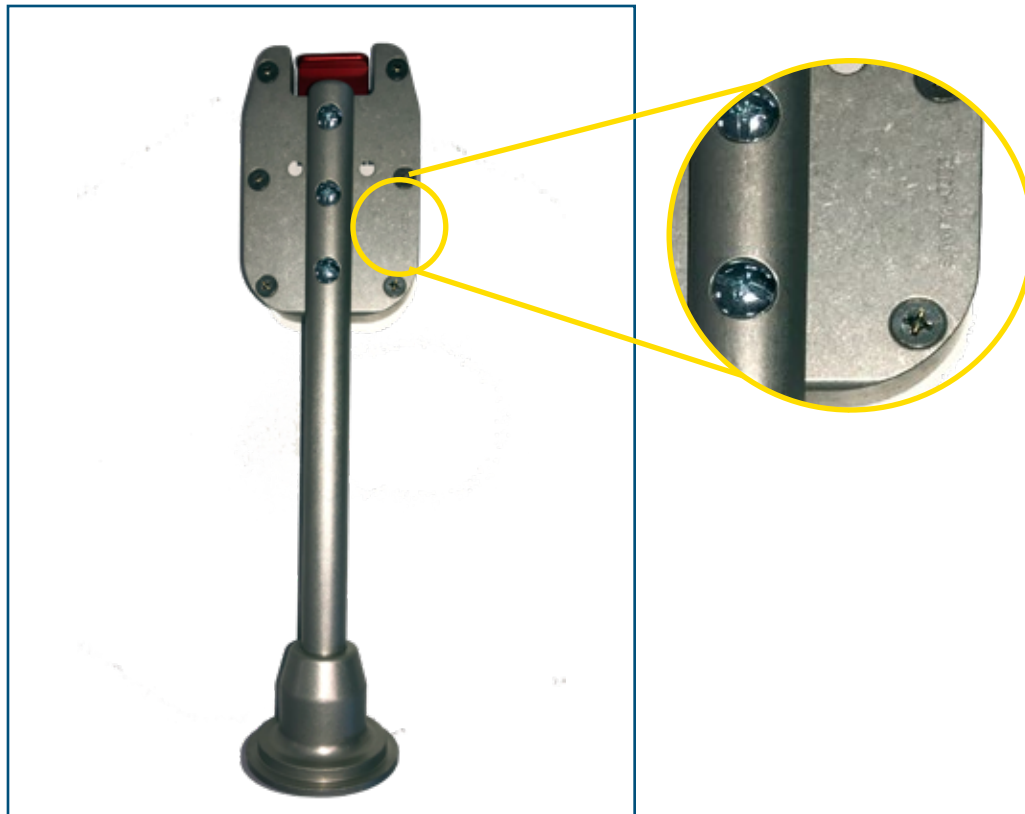

FIGURE 1. SAFETY MD TRANSPORTER POST

[Return To Table of Contents](#)

TABLE OF CONTENTS

COPYRIGHT	2
CONTACT INFORMATION.....	3
INTRODUCTION	6
PRODUCT DESCRIPTION	6
INTENDED USE OF THE PRODUCT	6
SYMBOLS AND DEFINITIONS	7
WARNING / CAUTION / NOTE.....	8
IDENTIFICATION OF COMPONENTS.....	9
<i>IV PRO ADAPTER.....</i>	<i>9</i>
<i>MICRO BASE.....</i>	<i>9</i>
<i>SAFETY MD TRANSPORTER.....</i>	<i>9</i>
SPECIFICATIONS.....	10
CERTIFICATION	12
PRODUCT ILLUSTRATION.....	13
SUMMARY OF SAFETY PRECAUTIONS	14
WARNING/CAUTION/NOTE	14
INSTALLATION GUIDE	16
REMOVING PACKAGING FOR INSTALLATION	16
TOOLS REQUIRED FOR INSTALLATION.....	16
COT/STRETCHER ORIENTATION DIAGRAM	17
PREPARING THE COT/STRETCHER FOR INSTALLATION	18
<i>REMOVING THE IV POLE.....</i>	<i>18</i>
SAFETY MD TRANSPORTER INSTALLATION.....	20
<i>PREPARING THE IV PRO ADAPTER PLATE.....</i>	<i>20</i>
<i>INSTALLING THE MICRO BASE ON THE IV PRO ADAPTER PLATE</i>	<i>21</i>
<i>POSITION ON THE COT/STRETCHER</i>	<i>22</i>
<i>PATIENT RIGHT AND LEFT INSTALLATION.....</i>	<i>22</i>
<i>INSTALLING THE IV PRO ADAPTER.....</i>	<i>23</i>
<i>INSTALLING THE IV POLE AND HOLDER ONTO THE IV PRO ADAPTER.....</i>	<i>26</i>
<i>INSTALLING THE SAFETY MD TRANSPORTER POST INTO THE MICRO BASE.....</i>	<i>28</i>
OPERATION GUIDE	30
GENERAL OPERATING GUIDELINES.....	30
OPERATING BRACKET WITH THE SAFETY MD TRANSPORTER	31
<i>INSTALLING THE BRACKET ONTO THE SAFETY MD TRANSPORTER.....</i>	<i>31</i>
<i>ROTATING THE BRACKET ON THE SAFETY MD TRANSPORTER</i>	<i>32</i>
<i>REMOVING THE BRACKET FROM THE SAFETY MD TRANSPORTER.....</i>	<i>33</i>
SAFETY MD TRANSPORTER PART NUMBERS	34
PART NUMBERS FOR STRYKER POWERPRO COT/STRETCHERS	34
<i>SAFETY MD TRANSPORTER WITH THE VERTICAL MICRO BASE - VERSION 1.....</i>	<i>34</i>
<i>SAFETY MD TRANSPORTER WITH THE HORIZONTAL MICRO BASE - VERSION 2.....</i>	<i>34</i>
MAINTENANCE GUIDE.....	35
CLEANING THE SAFETY MD TRANSPORTER	35
<i>CLEANING PROCESS.....</i>	<i>35</i>
<i>CLEANING SOLUTIONS.....</i>	<i>35</i>
<i>REMOVAL OF IODINE COMPOUNDS</i>	<i>36</i>
PREVENTIVE MAINTENANCE	36
<i>LUBRICATION</i>	<i>36</i>

TABLE OF CONTENTS

INSPECTION PROCESS AND SCHEDULE.....	37
<i>PREVENTIVE MAINTENANCE PROGRAM</i>	37
INSPECTION AND MAINTENANCE RECORD.....	38
TRAINING RECORD.....	39
REPLACEMENT PARTS.....	40
WARRANTY	41
WARRANTY POLICY	41
WARRANTY OPTIONS	42
<i>THREE WARRANTY OPTIONS FOR TECHNIMOUNT PRODUCTS</i>	42
INTERNATIONAL WARRANTY CLAUSE	42
RETURN POLICY	43
RETURN OF MERCHANDISE	43
<i>PRIOR TO 30 DAYS</i>	43
<i>PRIOR TO 45 DAYS</i>	43
<i>PRIOR TO 60 DAYS</i>	43
<i>RETURN MERCHANDISE AUTHORIZATION</i>	43
<i>DAMAGED MERCHANDISE</i>	43

INTRODUCTION

This User Guide is designed to assist you with the installation, operation and maintenance of the Technimount **Safety MD Transporter**[®]. Please read this User Guide thoroughly before using this equipment. To ensure the safe operation of this equipment, it is recommended to train staff prior to use.

PRODUCT DESCRIPTION

The Technimount **Safety MD Transporter**[®] is a mounting system that consists of a micro base, mounted vertically (version 1) on a post, installed on Technimount's **IV Pro Adapter**[®] on another micro base on the side frame of the cot/stretcher. It is designed to support and transport portable medical devices with a maximum weight of twenty-five (25) lbs. in pre-hospital and hospital environments. The **Safety MD Transporter**[®] can be removed and stored safely when not in use. When used in emergency vehicles with a cot/stretcher, the **Safety MD Transporter**[®] rotates 360° for easy access to the medical device during transport and loading/unloading of the patient on the cot/stretcher.

The **Safety MD Transporter**[®] is inserted into the micro base equipped with a locking mechanism and can accept any type of mounting bracket equipped with an anti-rotation disc on the back. The **Safety MD Transporter**[®] is available for the right or the left side of the cot/stretcher. The **IV Pro Adapter**[®] is required to install the **Safety MD Transporter**[®]. Another version of the post (version 2) is also available with a horizontal micro base on the top to mount different equipment, according to the space available and other equipment installed around the mount.

INTENDED USE OF THE PRODUCT





The **Safety MD Transporter**[®] is a secure mounting system for portable medical devices, designed to be installed on Stryker PowerPro™ cot/stretchers. The mount is intended to support and transport medical equipment during a medical intervention of a traumatized, an ambulatory or non-ambulatory patient (including infants, children and adults).

Once the **Safety MD Transporter**[®] is installed, it facilitates the safe transport of smaller portable medical equipment (i.e. defibrillator and/or pumps) in emergency vehicles. The use of the **Safety MD Transporter**[®] was designed to be used on an ambulance cot/stretcher and is intended for front-line responders who have received the training necessary to operate the System in the field. It's designed to work with other products on a cot/stretcher, such as the **Safety Arm System**[®]. The **Safety MD Transporter**[®] is intended for transport purposes only. It shouldn't carry more than one medical device. It is not intended for more than one unit or any additional equipment attached to the post.

The **Safety MD Transporter**[®] is compatible only with Technimount's mounting solutions that have an anti-rotation disc on the back for version 1 or a standard micro disc on the bottom for version 2.



The expected service life of the **Safety MD Transporter**[®] is approximately five (5) years, depending upon use.

SYMBOLS AND DEFINITIONS

SYMBOL	DESCRIPTION
	Caution, special attention is required. Consult accompanying documents
	Safe working load symbol
	Pinch Point
	Load balance symbol

WARNING / CAUTION / NOTE

The word warning, caution, or note carry special meaning and should be carefully reviewed.

	<p>WARNING</p> <p>Alerts the reader about a situation which, if not avoided, could result in death or serious injury. It may also describe potential serious adverse reactions and safety hazards.</p>
	<p>CAUTION</p> <p>Alerts the reader of a potentially hazardous situation, which, if not avoided, may result in minor or moderate injury to the user or patient or damage to the equipment or other property. This includes special care necessary for the safe and effective use of the device to avoid damage that may occur as a result of use or misuse.</p>
<p>NOTE</p>	<p>Provides special information about the product.</p>

IDENTIFICATION OF COMPONENTS

IV PRO ADAPTER

- The IV Pro Adapter is a long black plate.
- The IV Pro Adapter is installed on the cot/ Stretcher side rail.
- It is needed to install the micro base, the Safety MD Transporter and the IV Pole together on the cot/stretchers.



MICRO BASE

- The round base of the Safety MD Transporter inserts into the Micro Base.
- The locking mechanism secures the Safety Transporter in place.
- The red quick release button is used to quickly release the device from the Micro Base.

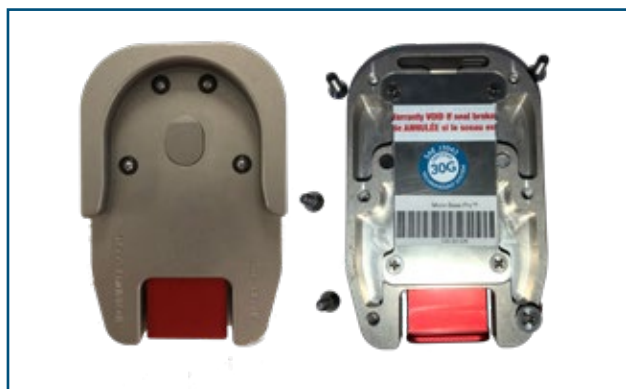

SAFETY MD TRANSPORTER

- The Safety MD Transporter post is provided with a micro base.
- It has a round base at the bottom which inserts into the Micro Base.
- It comes with 2 blocks that are needed to install the IV pole. NOTE: the 2 blocks are different in size. The longer block must go on left side of the plate (opposite the pointed end).
- It can rotate 360° for easy access to the medical device at all times.
- The Micro Base on the top of the Safety MD Transporter is used to hold the medical device.
- The Safety MD Transporter can hold a maximum weight of 25 pounds.



[Return To Table of Contents](#)

INTRODUCTION

SPECIFICATIONS

Cot / Stretcher Brand and Model Available	Stryker Stretcher / Cot
 <p>Note: Safe Working Load Safe Working Load indicates the sum of the medical device and accessory weight</p>	25 lbs
Model	Safety MD Transporter
Cot / Stretcher Compatibility	Pro XT, PowerPro, model 6085-6086, 6500 and 6506
Part Number (Depending on Cot Model)	540-00-PFXT-XX-XXXX Contact customer service for part numbers and options
Positions Available	Right or Left Side of the cot/stretcher
Material Manufacturing	High-grade aluminium
Cot Installation	Screwed into the side frame with actual holes on cot; needs IV Pro Adapter
Positioning Installation	Over an IV Pro Adapter - With or without knee gatch
Dimensions (Inches)	
<ul style="list-style-type: none"> Total Height 	16 in
<ul style="list-style-type: none"> Total Height 	4 in
Weight	
<ul style="list-style-type: none"> Total system (hardware included) 	6.8 lbs
Colors available	- Silver-anodized finish for the Safety MD Transporter - Black for the IV Pro Adapter
Angle of the base plate with the arm	90°
Maximum Load Capacity	25 lbs
Installation Holes for the Micro Base	5
Recommended Loading Position	Vertical
Recommended Number of Operators	2

INTRODUCTION

SPECIFICATIONS (CONTINUED)

Surface Base Mount Compatibility	Bracket Pro Standard and extended base
Impact Resistance Testing SAE J3043	30 G
Installation Time	~ 15 minutes
Estimated Time to Remove Vertical Post	Less than 5 seconds
Standards	SAE J3043, KKK-A-1822, NFPA 2016 Edition

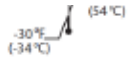
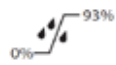
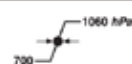
ENVIRONMENTAL CONDITIONS	OPERATION
Temperature	-30 °F (-34 ° C) to 130 °F (54 °C) 
Relative humidity	
Atmospheric pressure	

CAUTION

- ✓ Any changes or modifications to the product will void the warranty.
- ✓ Technimount system reserves the right to change specifications without notice.

[Return To Table of Contents](#)

CERTIFICATION

The Safety MD Transporter™ is designed to comply with Federal Specifications for the Star-of-Life Ambulance (KKK-A-1822), NFPA 1917- 2018 Edition, BS EN 1789 and SAE J3043.

Technimount hereby declares that this Safety MD Transporter™ is in compliance with the essential requirements and other relevant provisions of the Directive 1999/5/EC and SAE J3043. A copy of the original declaration of conformity can be obtained by contacting Technimount System's Regulatory Affairs Department:

TECHNIMOUNT SYSTEM

BRAND OF TECHNOLOGIES CGC

C/O: Regulatory Affairs

3770 Jean Marchand Street, Suite 100

Quebec (QC) G2C 1Y6

Canada

T + 1 581.998.9820

F + 1 855.339.6351

technimount.com

info@technimount.com

PRODUCT ILLUSTRATION

Safety MD
Transporter Vertical
Micro Base Installed



Safety MD
Transporter Post



Micro Disc at the
Base of the Safety
MD Transporter
Post Inserts into
the Horizontal
Micro Base on the
IV Pro Adapter



SUMMARY OF SAFETY PRECAUTIONS

WARNING/CAUTION/NOTE

Carefully read and strictly follow all Warnings and Cautions listed in this manual. Servicing and maintenance should only be done by qualified personnel.

WARNING

- ✓ To avoid injury, hands should be clear of the Micro Base while installing the medical equipment.
- ✓ Improper usage of the Safety MD Transporter can cause serious injury to the patient or operator. Operate only as described in this user guide.
- ✓ Do not modify the Safety MD Transporter or any components of the system. Modifying the product can cause unpredictable operation resulting in injury to the patient or operator.
- ✓ It is the responsibility of the operator of the cot/stretchers to ensure that the Safety MD Transporter being used with Technimount products meets the installation specifications. Injury may result if non-compatible products are used with Technimount System products.
- ✓ Do not allow untrained staff to assist in the operation of the Safety MD Transporter. Untrained technicians/staff can cause injury to the patient or themselves.
- ✓ Do not sit or ride on the pole, damage to the product could occur, and may result in injury to the patient or operator.
- ✓ Grasping the Safety MD Transporter improperly can cause injury. Keep hands, fingers and feet away from moving parts.
- ✓ Operators must be able to safely lift the total weight of the Safety MD Transporter (post and medical device), and any items attached to the medical device.
- ✓ Do not attach restraints to the post, the Micro Base, or any other place of the system. It may result in damage to the system or equipment and/or result in injury to the patient or operator.
- ✓ Do not place any additional equipment or objects on the Safety MD Transporter, other than approved Technimount System device brackets for medical devices.
- ✓ Always avoid any improper pushing or violent manipulation, as it may result in an unbalanced cot/stretchers and may cause injury to the patient or operator and/or damage to the product.
- ✓ To avoid the risk of patient injury or equipment damage, ensure that you properly mount and secure the medical device to the Micro Base.
- ✓ To avoid the risk of patient injury or equipment damage, you must ensure that the disc attached to the bracket under the medical device is properly locked into the Micro Base base.
- ✓ Improper maintenance can cause injury or damage to the product. Maintain the Safety MD Transporter as described in this user guide. Use only Technimount approved parts and maintenance procedures. Using unapproved parts and procedures could cause unpredictable operation and/or injury and will void the product warranty.
- ✓ Failure to properly clean or dispose of corrosive products will increase the risk of premature damage and may cause injury to the patient or operator.
- ✓ Ensure proper hand placement on a high position on the post. Hands should be clear of Micro Base while loading and unloading the Safety MD Transporter.
- ✓ Do not adjust or remove the Safety MD Transporter while you are moving with the cot/stretchers.

SUMMARY OF SAFETY PRECAUTIONS

WARNING/CAUTION"NOTE (CONTINUED)



CAUTION

- ✓ Certified technical personnel familiar with the cot/stretchers specifications should complete the installation of the Safety MD Transporter. Refer to the cot/stretchers manufacturer's manual before installing the Safety MD Transporter and ensure that the installation does not damage or interfere with the use of the cot/stretchers.
- ✓ Inspect regularly the Safety MD Transporter and micro base for any issue and loose screws.

NOTE

- ✓ Some cleaning products are corrosive in nature and may cause damage to the product if used improperly. If such products are used to clean Technimount equipment, the equipment must be rinsed with clean water and thoroughly dried following the cleaning. Failure to properly rinse and dry the Safety MD Transporter will leave a corrosive residue on the surface, possibly causing premature corrosion of critical components.
- ✓ Installation of the Safety MD Transporter was designed to be placed on either side of the stretcher with the use of the **right** or the **left** Safety MD Transporter (patient right or left). When ordering, it is important to identify which side the Safety MD Transporter is to be located. The Safety MD Transporter cannot be reversed as the black metal plate (IV Pro Adapter plate) has been designed for a specific side.
- ✓ A preventative maintenance program should be established for all Technimount equipment. Preventative maintenance may need to be performed more frequently, based on the level of use of the product.
- ✓ Failure to use authorized parts, and lubricants, etc., could cause damage to the Safety MD Transporter and will void the warranty of the product.
- ✓ This user guide should be considered a permanent part of the Safety MD Transporter and should remain with the product.
- ✓ Technimount continually seeks advancements in product design and quality. Therefore, while this manual contains the most current product information available at the time of printing, there may be minor discrepancies between your Safety MD Transporter and this user guide.

If you have any questions, please contact Technimount Customer Service or Technical Support at +1.581.998.9820.

REMOVING PACKAGING FOR INSTALLATION

1. Unpack boxes and check all items for proper operation.
2. Ensure that all shipping and packaging materials have been properly removed from the product(s) prior to installation.
3. Identify all of the product components and hardware prior to starting the installation.
4. Some hardware or parts provided might not be applicable to the model of your cot/stretcher.
5. The Safety MD Transporter must work properly before it is put into service.
6. Refer to the identification of components at the beginning of this user guide if needed.

NOTE

- ✓ Loose items or debris on the cot/stretcher can interfere with the operation of the Safety MD Transporter and cot/stretcher. Keep the cot/stretcher and the floor clear.

TOOLS REQUIRED FOR INSTALLATION

Below are the basic tools required for installation. Other tools may also be needed. If you have any questions regarding the installation, or need assistance, please contact our Technical Support team at techsupport@technimount.com



FIGURE 2. ALLEN KEY 5/32 IN



FIGURE 3. S2-T27 STAR BIT
SCREWDRIVER

NOTE

- ✓ Electrical tools are not recommended for screwing into the cot/stretcher frame, as there is a potential risk of damage to the threads.

INSTALLATION GUIDE

COT/STRETCHER ORIENTATION DIAGRAM

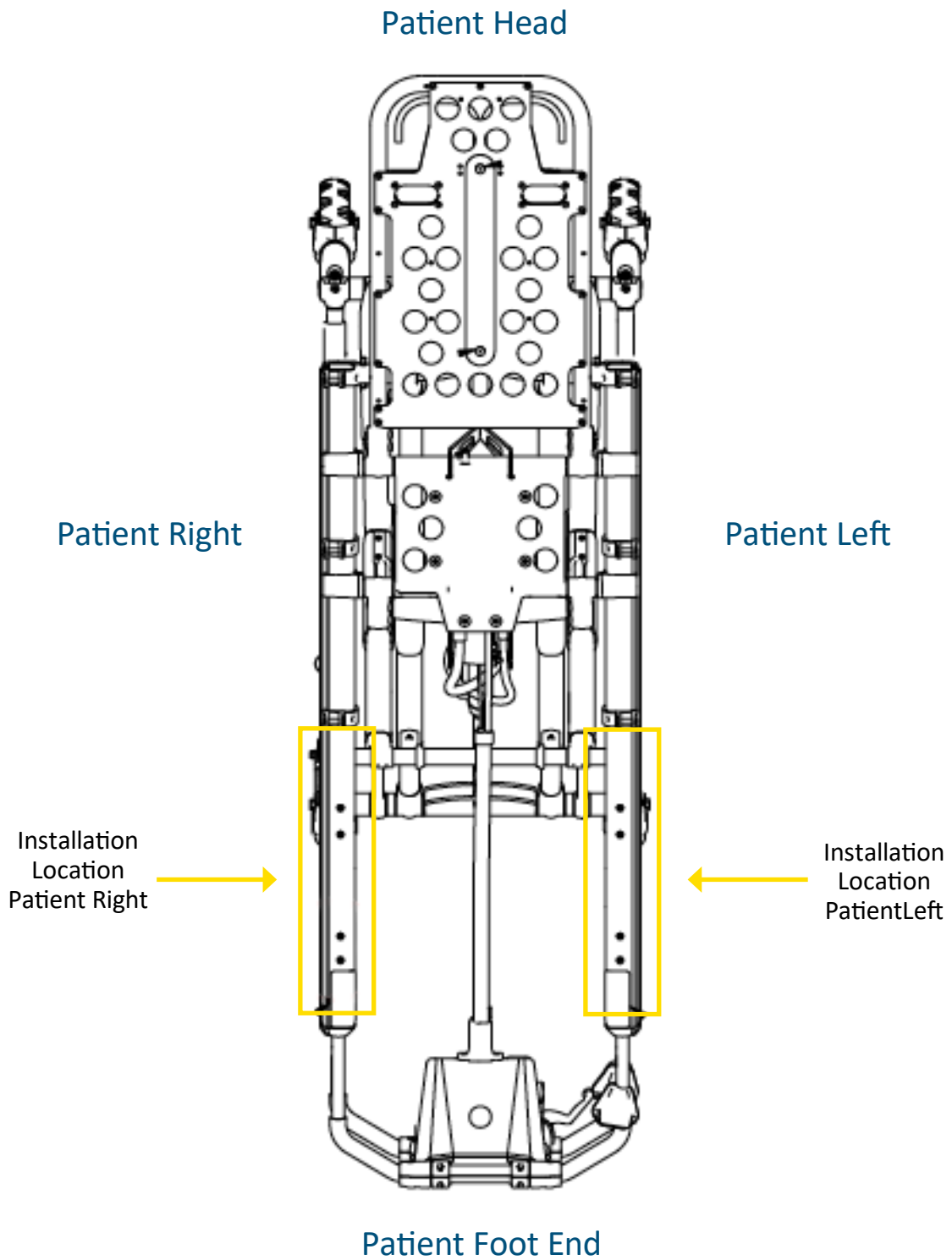

[Return To Table of Contents](#)

PREPARING THE COT/STRETCHER FOR INSTALLATION

[REMOVING THE IV POLE](#)

[NOTE](#)

- ✓ If the cot/stretchers has an IV pole located on the side you want to install the Safety MD Transporter, you will need to remove the IV Pole.
- ✓ To keep the IV pole on the same side as the cot/stretchers, you will need to install it on the IV Pro Adapter.
- ✓ You will need to validate the location of the installation before removing the IV pole hardware. The IV Pro Adapter is designed for either the right or left side.
- ✓ Technimount has **two (2) Safety MD Transporter models, one with a vertical Micro Base (version 1) and the other with a horizontal Micro Base (version 2).**
- ✓ The installation procedure provided in this user guide is for **Patient Right** installation. The procedure is the same for both right and left sides.
- ✓ You might not have to perform these steps if you do not have an IV pole installed.
- ✓ Please validate if your cot has the “knee Gatch” feature or not; It will dictate the exact IV Pro Adapter model, for the proper installation on the cot.
- ✓ Please refer to the cot/stretchers manufacturer’s manual for more information about installation/re-installation of the IV pole.

INSTALLATION GUIDE

PREPARING THE COT/STRETCHER FOR INSTALLATION (CONTINUED)

REMOVING THE IV POLE (CONTINUED)

1. To access screws that hold the IV pole and the holder, lift the IV pole to its upper position.



2. Remove all four (4) screws.
3. Remove IV Pole and holder.
4. Keep the IV Pole and holder and set aside to install on the IV Pro Adapter plate in a later step.



SAFETY MD TRANSPORTER INSTALLATION

PREPARING THE IV PRO ADAPTER PLATE

1. Install the 2 blocks provided with Safety MD Transporter onto the IV Pro Adapter plate.

NOTE:

- ✓ Ensure to install the short block on the side of the IV Pro Adapter plate with pointed end.

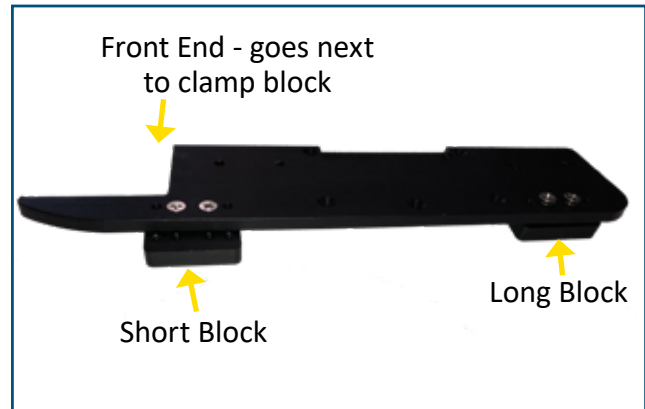

2. Using screwdriver with a star bit, tighten all 4 screws (2 on each block).
3. Insert screws from the bottom of the IV Pro Adapter plate.

NOTE

- ✓ Installation of the blocks is performed underneath of the plate, in order to have the blocks on the upper side once installed.

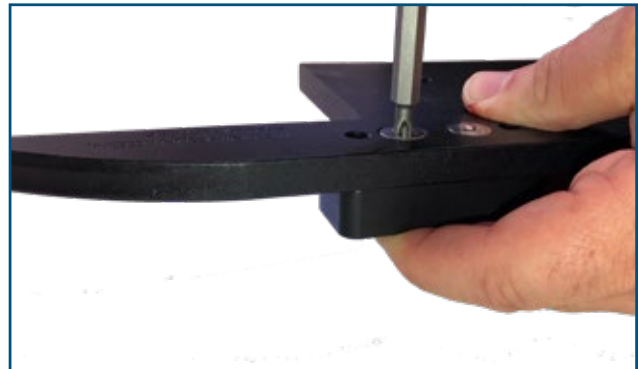

4. IV Pro Adapter plate with the 2 blocks installed.



INSTALLATION GUIDE

SAFETY MD TRANSPORTER INSTALLATION (CONTINUED)

INSTALLING THE MICRO BASE ON THE IV PRO ADAPTER PLATE

1. Five (5) screws are provided to install the Micro Base onto the IV Pro Adapter plate.



2. Align with the five (5) screw holes.



3. Add a couple of drops of blue Loctite to the screws before installation.
4. Tighten screws, while alternating screwheads.



INSTALLATION GUIDE

SAFETY MD TRANSPORTER INSTALLATION (CONTINUED)

POSITION ON THE COT/STRETCHER

Patient Right and Left Installation

CAUTION

- ✓ It is the responsibility of the Safety MD Transporter operator to ensure that the system being used on the cot/stretcher meets the installation specifications. Injury may result if a non-compatible cot is used.

NOTE

- ✓ When ordering the Safety MD Transporter, it is important to specify on which side the it will be installed on, as the System cannot be installed on the opposite side. There is a right and left Safety MD Transporter designed for each side.
- ✓ The Safety MD Transporter cannot be switched from one side to the other. You need to order a system according to the side that is needed.
- ✓ The location for the installation of the IV Pro Adapter is the same on patient right or left sides.

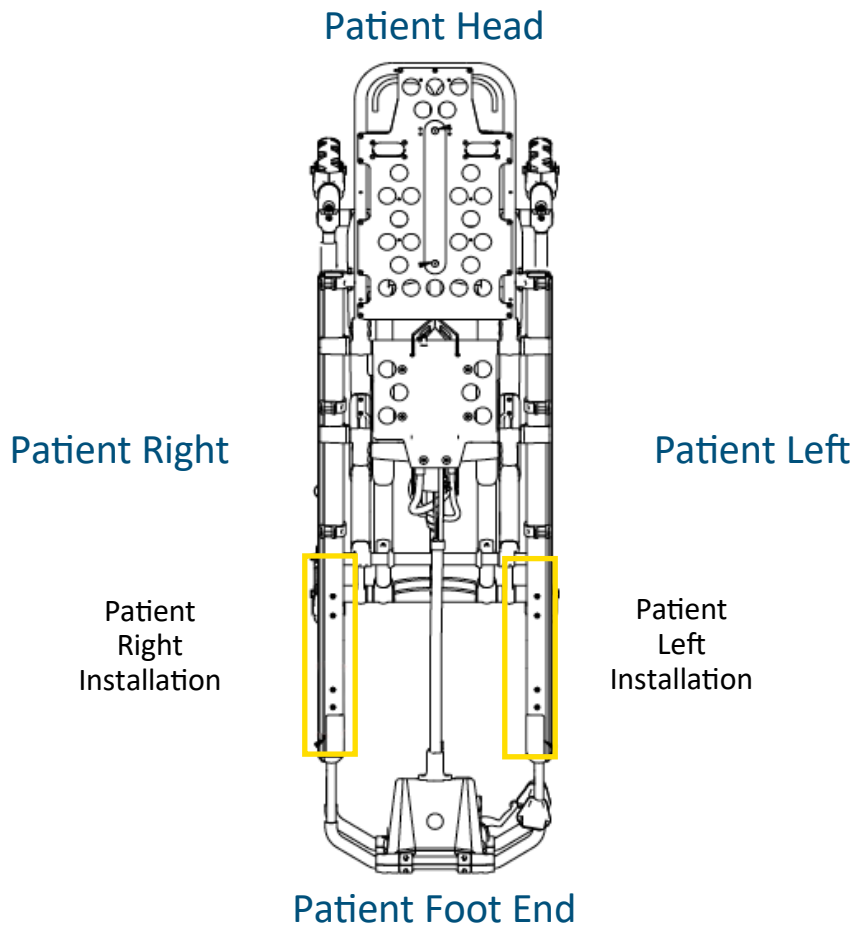

FIGURE 4. SAFETY MD TRANSPORTER - INSTALLATION POSITION ON PATIENT RIGHT AND LEFT SIDES

INSTALLATION GUIDE

SAFETY MD TRANSPORTER INSTALLATION (CONTINUED)

INSTALLING THE IV PRO ADAPTER

NOTE

- ✓ During the installation process, Technimount System recommends the use of Loctite 2400 (Blue) to avoid premature loosening of screws during normal use.



The Loctite™ Brand shown above is provided as a suggestion only. Technimount System and its subsidiaries are not related to, nor does it commercially endorse this brand.

1. Identify the location on the cot/stretcher where you need to install the IV Pro Adapter.

NOTE

- ✓ Make sure the IV Pro Adapter will correspond to the feature of the stretcher/cot with or without the knee gatch. The knee gatch feature will require two (2) recesses on the IV Pro Adapter plate, the one without knee gatch will have only one (1) long recess to obtain the proper fit on the stretcher/cot.



2. Pull and hold the Safety Pin (red round handle) while putting a pair of pliers to hold the pin open.

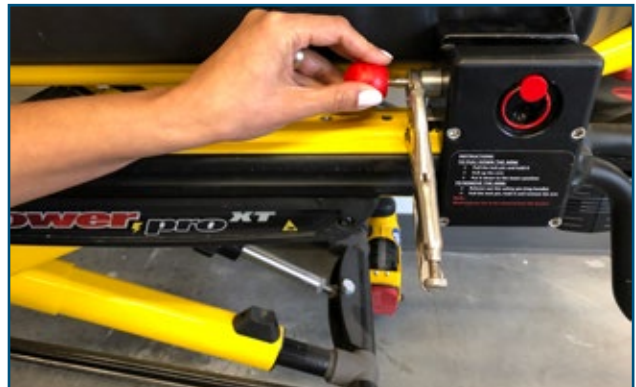

[Return To Table of Contents](#)

INSTALLATION GUIDE

SAFETY MD TRANSPORTER INSTALLATION (CONTINUED)

INSTALLING THE IV PRO ADAPTER (CONTINUED)

- When pliers are secured in place on the screw to hold the Safety Pin open, turn the red round handle counter clockwise to unscrew and remove the red round handle.

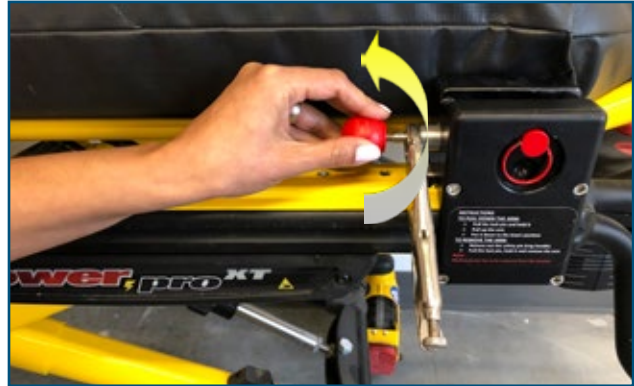

- Remove the red round handle.

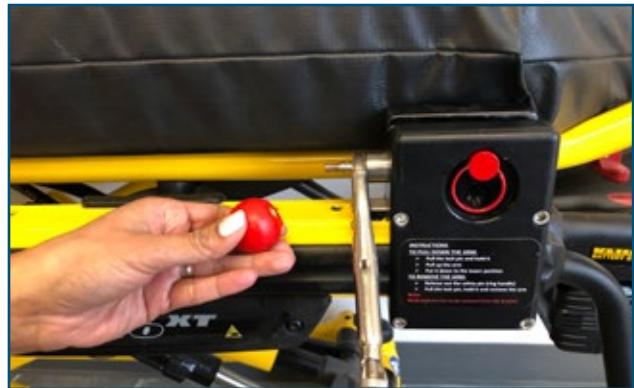

- Locate all 4 screw holes on the stretcher frame.



SAFETY MD TRANSPORTER INSTALLATION (CONTINUED)

INSTALLING THE IV PRO ADAPTER (CONTINUED)

6. Align IV Pro Adapter plate with the 4 screw holes on the cot/stretcher
7. Put a few drops of blue Locktite on each screw.
8. Tighten all four (4) screws while alternating screwheads



9. Push pin from the inside of the clamp block outward and place a pair of pliers on the screw to hold open while you replace the red round handle.
10. Put on a pair of gloves in order to put some blue Locktite onto the safety pin screw.



WARNING

- ✓ Use safety glasses to protect the eyes. Use impermeable gloves and protective clothing as necessary to prevent skin contact.
11. Put a few drops of blue Locktite onto the screw before replacing the red round handle. This will prevent premature loosening of the screws during normal use.



INSTALLATION GUIDE

SAFETY MD TRANSPORTER INSTALLATION (CONTINUED)

INSTALLING THE IV PRO ADAPTER (CONTINUED)

12. Replace the red round handle while turning clockwise.
13. Screw in tightly.

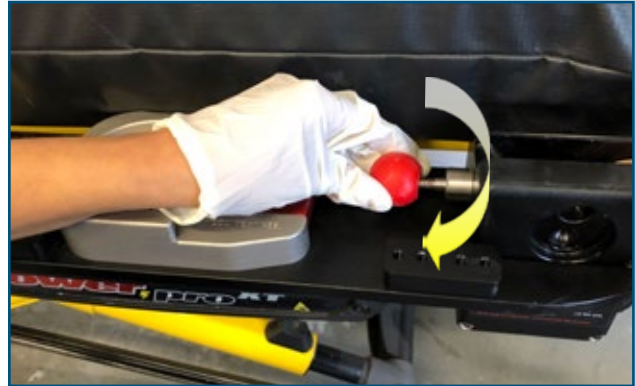

INSTALLING THE IV POLE AND HOLDER ONTO THE IV PRO ADAPTER

1. Locate the 2 blocks on either side of the IV Pro Adapter plate.

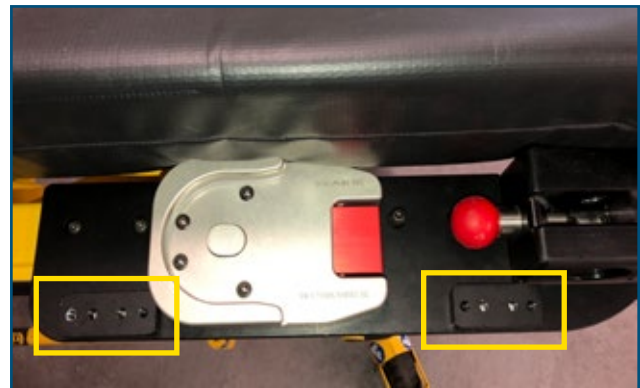

2. Install the IV Pro Holder onto the block located near the Clamp Block.
3. Align with the two (2) screw holes.
4. Tighten both screws.



INSTALLATION GUIDE

SAFETY MD TRANSPORTER INSTALLATION (CONTINUED)

INSTALLING THE IV POLE AND HOLDER ONTO THE IV PRO ADAPTER (CONTINUED)

5. Install the IV pole onto the IV Pro Adapter plate second block
6. Align with the two (2) screws holes.
7. Use the same screws provided with the IV Pole or similar screws provided, with same threads and length.
8. Tighten both screws.



9. When not in use, lower the IV pole and clip it into its holder.



INSTALLATION GUIDE

SAFETY MD TRANSPORTER INSTALLATION (CONTINUED)

INSTALLING THE SAFETY MD TRANSPORTER POST INTO THE MICRO BASE

1. Lift the IV Pole upright.



2. Slide the round base of the Safety MD Transporter to secure it onto the Micro Base.

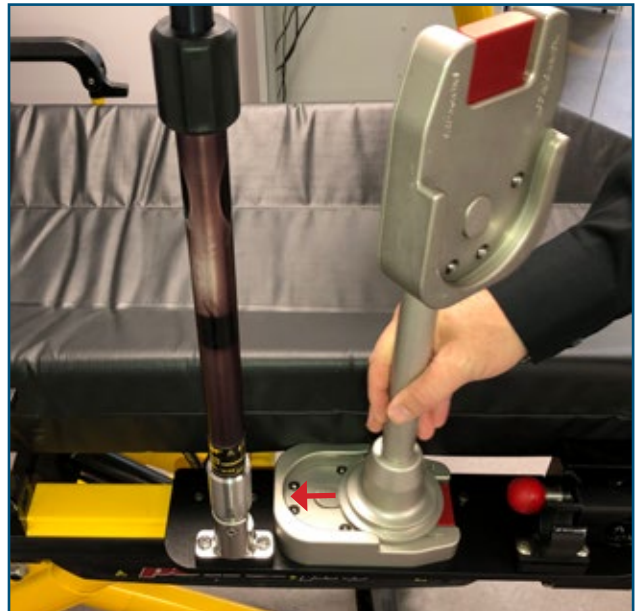

INSTALLATION GUIDE

SAFETY MD TRANSPORTER INSTALLATION (CONTINUED)

INSTALLING THE SAFETY MD TRANSPORTER POST INTO THE MICRO BASE (CONTINUED)

3. Safety MD Transporter installed on the micro base.



4. If the IV Pole is not needed, you can fold and place the IV Pole into its holder. It fits perfectly beside the clamp block located on the cot/stretcher.



GENERAL OPERATING GUIDELINES

- ✓ Use the Safety MD Transporter only as described in this User Guide.
- ✓ Read all the labels and instructions on the product before using the Safety MD Transporter.
- ✓ Always inspect the Micro Base and the Safety MD Transporter for any issue or damage before every use.
- ✓ Installing or removing the Safety MD Transporter requires a minimum of one (1) trained operator.
- ✓ Do not remove the Safety MD Transporter while moving with the cot/stretcher.
- ✓ Stay with the patient and control the Safety MD Transporter at all times.



WARNING

- ✓ Never let a patient grab, manipulate or hold the Safety MD Transporter, or the Micro Base on the cot/stretcher because it may cause injury to the operator or patient. Secure the Safety MD Transporter as recommended while the patient is on the cot/stretcher.

OPERATING BRACKET WITH THE SAFETY MD TRANSPORTER

INSTALLING THE BRACKET ONTO THE SAFETY MD TRANSPORTER

1. Only Technimount brackets with an anti-rotation micro disc on the back can be inserted into the Micro Base located on the Safety MD Transporter.
2. Ensure that your bracket has an anti-rotation micro disc on the back to install the medical device onto the Safety MD Transporter.



3. While using both hands, slowly insert anti-rotation disc located on the back of the bracket into the Micro Base.

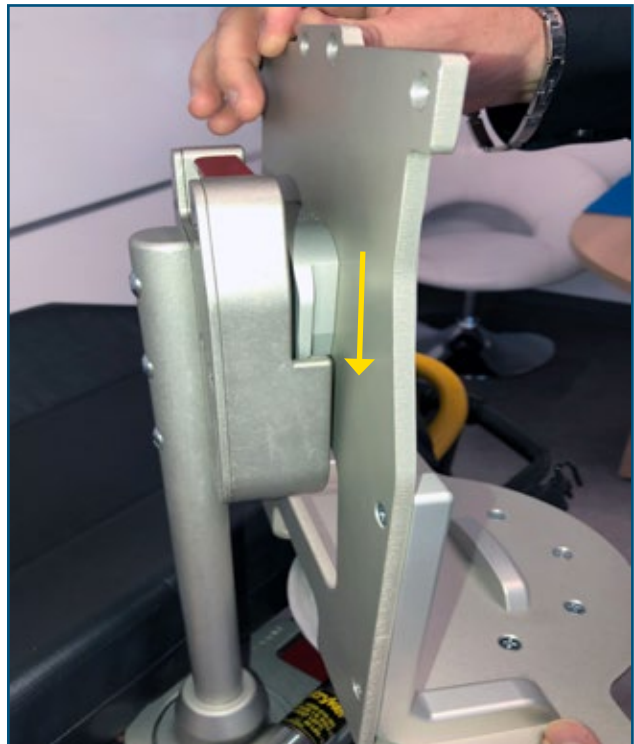

OPERATING THE SAFETY MD TRANSPORTER (CONTINUED)

INSTALLING THE BRACKET ONTO THE SAFETY MD TRANSPORTER (CONTINUED)

4. A Technimount bracket with an anti-rotation micro disc on the back installed on the Safety MD Transporter.



ROTATING THE BRACKET ON THE SAFETY MD TRANSPORTER

1. To rotate the Safety MD Transporter with the medical device 360°, turn the Safety MD Transporter clockwise or counter clockwise.



OPERATING THE SAFETY MD TRANSPORTER (CONTINUED)

REMOVING THE BRACKET FROM THE SAFETY MD TRANSPORTER

1. To remove the bracket and medical device from the Safety MD Transporter, press the red quick release button located on the back Micro Base.
2. While holding the red quick release button, lift the bracket upwards in a straight line.

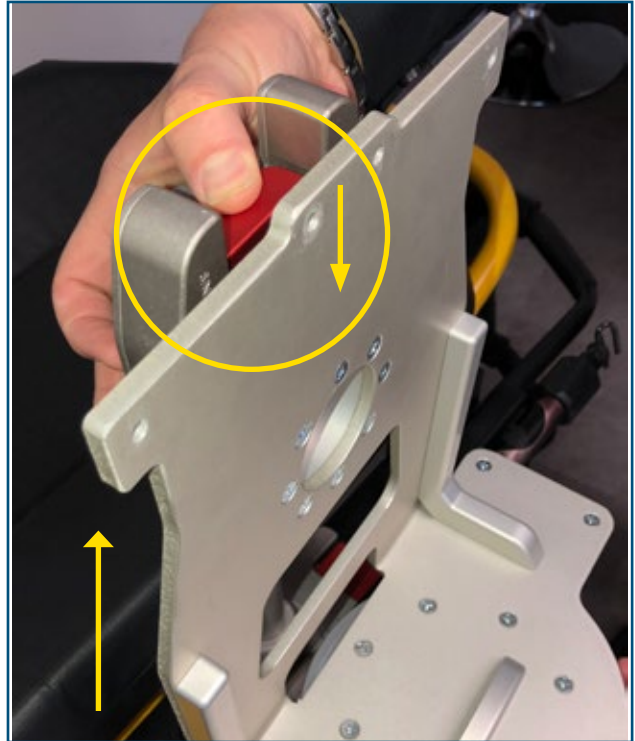

SAFETY MD TRANSPORTER PART NUMBERS

PART NUMBERS FOR STRYKER POWERPRO COT/STRETCHERS

Some exceptions may apply for the PowerPro Stretcher, please confirm with Customer Service at customerservice@technimount.com prior to placing your order.

SAFETY MD TRANSPORTER WITH THE VERTICAL MICRO BASE - VERSION 1

<u>DESCRIPTION</u>	<u>PART NUMBER</u>
The Safety MD Transporter Post	540-10-OL13
2 Blocks for the IV Pro Adapter	543-00-UN
Universal Micro Base with Quick Release Mechanism	120-20-UN
IV Pro Adapter – IV Pole Support – Patient Left Installation - Without Knee Gatch	511-00-UN-LFS - WHKG
IV Pro Adapter – IV Pole Support – Patient Left Installation - With Knee Gatch	511-00-UN-LFS - KG
IV Pro Adapter – IV Pole Support – Patient Right Installation - Without Knee Gatch	511-00-UN-RHS - WHKG
IV Pro Adapter – IV Pole Support – Patient Right Installation –With Knee Gatch	511-00-UN-RHS - KG

* For available kits, please contact Customer Service at customerservice@technimount.com.

SAFETY MD TRANSPORTER WITH THE HORIZONTAL MICRO BASE - VERSION 2

<u>DESCRIPTION</u>	<u>PART NUMBER</u>
The Safety MD Transporter Post (Angled Post)	540-10-OL14-ANG
2 Blocks for the IV Pro Adapter	543-00-UN
Universal Micro Base with Quick Release Mechanism	120-20-UN
IV Pro Adapter – IV Pole Support – Patient Left Installation - Without Knee Gatch	511-00-UN-LFS - WHKG
IV Pro Adapter – IV Pole Support – Patient Left Installation - With Knee Gatch	511-00-UN-LFS - KG
IV Pro Adapter – IV Pole Support – Patient Right Installation - Without Knee Gatch	511-00-UN-RHS - WHKG
IV Pro Adapter – IV Pole Support – Patient Right Installation –With Knee Gatch	511-00-UN-RHS - KG

* For available kits, please contact Customer Service at customerservice@technimount.com.

CLEANING THE SAFETY MD TRANSPORTER

CLEANING PROCESS

The Safety MD Transporter can be cleaned by using a pressure washer. The unit may show some signs of oxidation or discoloration from continuous washing, however, degradation of the cot's performance or functionality will not be affected due to power washing if cleaning instructions are properly followed.

The material used to manufacture the Safety MD Transporter is high-grade aluminum, it is very durable and resistant to corrosion, however high levels of sodium or a high concentration of sodium or acid may prematurely corrode the product. Always rinse with soft soap and water if exposed.

- ✓ Use of a power washer can accelerate removal of contaminants collected during the use of the product.
- ✓ Rinse with clean water.
- ✓ Towel dry all casters and interface points, inside the triangle head and clamp block.
- ✓ Allow all other components to air dry.
- ✓ Avoid over saturation and ensure that the product does not stay wet longer than the cleaner manufacturer's guidelines for proper disinfecting.



WARNING

- ✓ When cleaning, always use appropriate personal protection equipment (PPE) based on established protocols (e.g., gloves, eyewear, etc.).



CAUTION

- ✓ Do not steam clean or use ultrasonic cleaners on the system or any of its components.
- ✓ Do not immerse the metal parts/components in water.
- ✓ Maximum water temperature should not exceed 180°F/82°C
- ✓ Maximum water pressure should not exceed 1500 psi/103.5 BAR . If a pressure washer is being used to clean the unit, the pressure nozzle must be kept a minimum of 24 inches (61 cm) from the unit.

CLEANING SOLUTIONS

Phenolic type or quaternary type disinfectants can be used (excluding Virex® TB). Iodophor type disinfectants, Peracetic Acid, Chlorine, and especially Peroxide Oxygen are not recommended for use because staining and corrosion may result.

Suggested cleaners for the Safety MD Transporter surfaces and clamp box:

- ✓ Quaternary Cleaners (active ingredient - ammonium chloride)
- ✓ Phenolic Cleaners (active ingredient - o-phenyl phenol)
- ✓ Chlorinated Bleach Solution (3.25% - less than 1-part bleach to 100 parts water)

CLEANING THE SAFETY MD TRANSPORTER (CONTINUED)

CLEANING SOLUTIONS (CONTINUED)

WARNING

- ✓ Some cleaning products are corrosive in nature and may cause damage to the product if used improperly.
- ✓ If the products described above are used to clean the equipment, the Safety MD Transporter must be rinsed with clean water and thoroughly dried following cleaning. Failure to properly rinse and dry the Safety MD Transporter will leave a corrosive residue on the surface of the product, possibly causing premature corrosion of critical components.

REMOVAL OF IODINE COMPOUNDS

Use a solution of 1/4 Tablespoon of Sodium Thiosulfate in 1 pint / .5 litre of warm water to clean the stained area. Clean as soon as possible after staining occurs. If stains are not immediately removed, allow solution to soak or stand on the surface. Thoroughly rinse surfaces with clean water and allow to air dry before returning unit to service.

WARNING

- ✓ Failure to properly clean contaminated parts or components will increase the risk of exposure to blood borne pathogens and may cause injury to the patient or the operator.

PREVENTIVE MAINTENANCE

A preventive and regular maintenance program should be established for all Technimount equipment. Preventive maintenance may be required more frequently based on the usage level of the product. The Safety MD Transporter requires regular preventative maintenance. Establish and follow a preventive maintenance schedule and keep records of preventive maintenance activities.

CAUTION

- ✓ Close attention should be given to safety features including, but not limited to both micro bases, anti-rotation back disc, and post.
- ✓ Improper maintenance can cause injury or damage to the product. Maintain the product as described in this user guide.

LUBRICATION

The Safety MD Transporter has been designed to operate without the need for lubrication. Due to an anodization of the metallic parts, using a silicone-base lubricant can be used but it is not necessary. If you're not sure about the product to use, please contact technical support or customer service.

CAUTION

- ✓ Failure to use authorized parts, lubricants, etc. could cause damage to the cot/stretcher and will void the warranty of the product.

MAINTENANCE GUIDE

INSPECTION PROCESS AND SCHEDULE

PREVENTIVE MAINTENANCE PROGRAM

The following inspection routine and schedule is intended as a general guide for preventive maintenance of the Safety MD Transporter. Factors such as weather, environment, geographical location, and individual usage will necessitate different maintenance. If you are unsure as to how to perform these maintenance inspections or at what interval to perform these inspections, please contact your Technical Support Team at techsupport@technimount.com. Check each routine and replace damaged or worn out parts if necessary.

Follow table below in accordance to the timetable, whichever comes first.

<u>ITEM</u>	<u>ROUTINE</u>	<u>1 M</u> <u>OR</u> <u>2 H</u>	<u>3 M</u> <u>OR</u> <u>6 H</u>	<u>6 M</u> <u>OR</u> <u>12 H</u>	<u>12 M</u> <u>OR</u> <u>24 H</u>
Micro Base	<ul style="list-style-type: none"> ✓ Inspect Mechanism ✓ Inspect Red Quick Release Mechanism ✓ Inspect General Functionalities 	X			
Anti-Rotation Back Disc	<ul style="list-style-type: none"> ✓ Inspect Screws that hold the Disc ✓ Inspect the General Condition of the Disc ✓ Regularly Clean the the Disc 	X			
Safety MD Transporter Post	<ul style="list-style-type: none"> ✓ Inspect Screws that hold the Micro Base ✓ Inspect the General Condition of the Disc at the Base of the Post ✓ Inspect the Assembly of the Post ✓ Ensure There are no Loose Parts 	X			

REPLACEMENT PARTS

The parts and accessories listed are all currently available for purchase. Some of the parts identified on the assembly drawing parts in this user guide may not be individually available for purchase. Please call Technimount Customer Service or Technical Support : +1.581-998-9820 or at customerservice@technimount.com or techsupport@technimount.com for availability and pricing.

DESCRIPTION	PART NUMBER
The Safety MD Transporter Post (Version 1)	540-10-OL13
The Safety MD Transporter Post (Angled Post) (Version 2)	540-10-OL14-ANG
2 Blocks for the IV Pro Adapter	543-00-UN
Universal Micro Base with Quick Release Mechanism	120-20-UN
IV Pro Adapter – IV Pole Support – Patient Left Installation - Without Knee Gatch	511-00-UN-LFS - WHKG
IV Pro Adapter – IV Pole Support – Patient Left Installation - With Knee Gatch	511-00-UN-LFS - KG
IV Pro Adapter – IV Pole Support – Patient Right Installation - Without Knee Gatch	511-00-UN-RHS - WHKG
IV Pro Adapter – IV Pole Support – Patient Right Installation –With Knee Gatch	511-00-UN-RHS - KG
Screws for the Micro Base (star bit)	544-00-UN
Screws for the IV Pro Adapter	543-00-UN

WARRANTY POLICY

Original purchasers will obtain a one-year (1) limited warranty on all parts of the Safety MD Transporter and Micro Base. Technimount's obligation under this one-year (1) warranty is limited to supplying replacement parts and labor for any component or option of this system that is found to be defective, at Technimount's sole discretion.

Upon Technimount's request, purchaser shall return to Technimount's shipping warehouse any product or part (freight prepaid by Technimount) for which an original purchaser makes a warranty claim.

Any improper use or alteration or repair by unauthorized service providers shall void this warranty.

This statement constitutes Technimount's entire warranty with respect to the aforementioned equipment.

Technimount System makes no other warranty or representation either expressed or implied, except as set forth herein. There is no warranty of merchantability and there are no warranties of fitness for any particular purpose. In no event shall Technimount be liable hereunder for incidental or consequential damages arising from or in any manner related to sales or use of any such equipment.

Technimount System guarantees to the original Purchaser of the Hardware with which this Limited Warranty is included, that the Hardware will be free from Defects in workmanship and material under normal use for a period of one (1) year from the date that the Hardware was first purchased, which is defined as the Warranty Period. During the Warranty Period, the Hardware will be repaired or replaced according to the Limited Warranty without charge to purchaser for either parts or labor. The parts may be repaired or replaced with either new or refurbished parts. The product may be replaced for a new or refurbished product. For this Limited Warranty, refurbished means parts and products which have been returned to factory specifications. If the Hardware is repaired or replaced within the Warranty Period, the greater of the remaining warranty period will apply or three (3) months from the date of repair/replacement. If the Hardware is repaired or replaced after the Warranty Period has expired, the Warranty Period for the repair or replacement will expire three (3) months after the date of repair or replacement.

The Limited Warranty does not apply to normal wear that should result from normal use. It does not apply when the hardware or any component is opened, disassembled, or repaired by someone not authorized by Technimount and does not cover repair or replacement of any Hardware or part thereof damaged by: neglect, misuse, moisture, liquids, exposure to heat, accidents, abuse, and non-compliance with the instructions for installation and use supplied with the Hardware. The Limited Warranty does not cover physical damage to the surface of the Hardware.

The Hardware or product defined in this user guide as a mounting or bracket system for clipping and attaching medical equipment are specifically designed to fill this requirement. Any other use will void the warranty and Technimount will not be held liable for, or on any form of a claim if the product is modified or adapted for use.

WARRANTY OPTIONS

THREE WARRANTY OPTIONS FOR TECHNIMOUNT PRODUCTS

1. One-year (1) additional warranty after the original warranty has expired for parts and labor has terminated. Technimount guarantees to the original purchaser that its products should be free from manufacturing nonconformities that affect product performance and customer satisfaction for a period of one (1) year following the end date of the original warranty. Technimount's obligation under this warranty is limited to supplying replacement parts and labor for, or replacing for any product or option, that is found to be defective, at Technimount's sole discretion.
2. Two-year (2) additional warranty after the original warranty for parts and labor has terminated. Technimount guarantees to the original purchaser that its products should be free from manufacturing -nonconformities that affect product performance and customer satisfaction for a period of two (2) years following the end date of the original warranty. Technimount's obligation under this warranty is limited to supplying replacement parts and labor for any component or option of this system that is, found to be defective at Technimount's sole discretion.
3. Three- year (3) additional warranty after the original warranty for parts and labor has terminated. Technimount guarantees to the original purchaser that its products should be free from manufacturing nonconformities that affect product performance and customer satisfaction for a period of three (3) years following the end date of the original warranty. Technimount's obligation under this warranty is limited to supplying replacement parts and labor for any component or option of this system that is found to be defective, at Technimount's sole discretion.

INTERNATIONAL WARRANTY CLAUSE

This warranty reflects Canadian domestic policy. Warranty outside Canada may vary by country. Please contact your local Technimount representative for additional information.

RETURN POLICY

RETURN OF MERCHANDISE

The Safety MD Transporter® parts and/or components may be returned up to 60 days of receiving the product(s) if they meet the following guidelines:

PRIOR TO 30 DAYS

- ✓ 30-day money back guarantee in effect
- ✓ Technimount is responsible for all charges
- ✓ Returns will not be approved on modified item
- ✓ Charges may apply if damaged or missing items

PRIOR TO 45 DAYS

- ✓ Product must be unused, undamaged and in the original packaging
- ✓ Customer is responsible for a 20% restocking fee
- ✓ Reasons of returning the product must be provided in writing
- ✓ Returns will not be approved on modified or damaged item
- ✓ Charges may apply if damaged or missing items

PRIOR TO 60 DAYS

- ✓ Product must be unused, undamaged and in the original packaging
- ✓ Customer is responsible for a 30% restocking fee
- ✓ Reasons for returning the product must be provided in writing
- ✓ Returns will not be approved on modified or damaged item
- ✓ Charges may apply if damaged or missing items

RETURN MERCHANDISE AUTHORIZATION

Technimount's customer service department is responsible for approving any merchandise return and will provide an RMA (Return Merchandise Authorization) number to be printed on any returned merchandise. Technimount reserves the right to charge shipping and restocking fees on returned items. Customized, modified, or discontinued items not subject to return.

DAMAGED MERCHANDISE

ICC Regulations require that claims for damaged merchandise must be made with the carrier within fifteen (15) days of receiving merchandise. Do not accept damaged shipments unless such damage is noted on the delivery receipt at the time of receipt. Upon prompt notification, Technimount will file a freight claim with the appropriate carrier for damages incurred. Claim will be limited in amount to the actual replacement cost. In the event that this information is not received by Technimount within the fifteen (15) day period following the delivery of the merchandise, or the damage was not noted on the delivery receipt at the time of receipt, the customer will be responsible for payment of the original invoice in full.

NOTE

Claims for any short shipment must be made within thirty (30) days of invoice.



SAFETY AND FLEXIBILITY WHERE IT MATTERS MOST

TECHNIMOUNT SYSTEM - BRAND OF TECHNOLOGIES CGC

Corporate Headquarters

3770 Jean Marchand Street, Suite 100

Quebec (QC) G2C 1Y6

Canada

T + 1 581.998.9820

F + 1 855.339.6351

technimount.com

info@technimount.com

© Copyright 2020 Technimount System All Rights Reserved

Printed in Canada



TECHNIMOUNT
SYSTEM™

SMT UG 202002-R01