



TECHNIMOUNT
MEDICAL™

TECHNIMOUNT HEALTHCARE SYSTEM™

MODULARITY AND FLEXIBILITY THAT TRANSCENDS



technimount.com

THS PREMIUM IV STAND

Modular IV Stand for a Wide Range of Applications

From the light-duty model to the intensive use model that can support numerous IV bags, pumps or other medical devices the THS Premium IV Stand offers single, dual and triple-pole options as well as modular accessory configurations to meet the specific needs of any care unit.

As part of the THS family, the Premium IV Stand features our patented technologies: The Techni-Track provides maximum modularity and flexibility for accessory installation and interchangeability, as well as Technimount's Controlled Descending technology integrated in its IV pole for an easier height adjustment and IV bag installation and removal.

This low-noise, smooth gliding IV pole is also highly stable due to its unique six-wheel base design.



Controlled
Descending
Technology

Techni-Track
for Maximum
Modularity

Highly-Stable
Six-Caster Base

THIS PREMIUM IV STAND

FEATURES & BENEFITS

- Available in single, double and triple IV pole configurations
- Integrates a Controlled Descending patented technology in each IV pole for an easier height adjustment
- Features Techni-Track patented technology in its main structure for maximum modularity in accessory installation
- Multiple options for top poles with 4 stars or in-line IV bag hooks or 8 in-line IV bag hooks
- Height-adjustable handle with optional utility tray
- Optional single and double O₂ tank holder
- Medical grade power bar with surge protection
- Drainage bag hooks, cable management, optional basket, hand sanitizer and glove box holders
- Highly-stable and unique design base with white powder-coated paintSix 3-inch swivel casters made of urethane and impact-resistant nylon

OPTIONS



Single Pole



Dual Pole



Triple Pole



4 Star Hooks

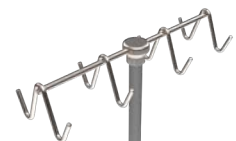

4 or 8 In-line Hooks

ACCESSORIES



Height Adjustable Handle



Drainage Bag Hook



Medical Grade Power Bar with Surge Protection



Hand Sanitizer Holder



Glove Box Holder

THS ERGO IV STAND

One-of-a-kind IV Stand that Integrate Ergonomics

The THS Ergo IV Stand has been developed with not only the medical staff, but also the patients in mind. The unique base design of the Ergo IV Stand facilitates walking with it and provides good stability and adequate foot space. The height-adjustable handle is designed for a comfortable posture while walking. Now patients can move around with their equipment confidently.

As part of the THS family, the Ergo IV Stand features our patented technologies: The Techni-Track provides maximum modularity and flexibility for accessory installation and interchangeability, as well as Technimount's Controlled Descending technology integrated in its IV pole for an easier height adjustment and smooth pole sliding.

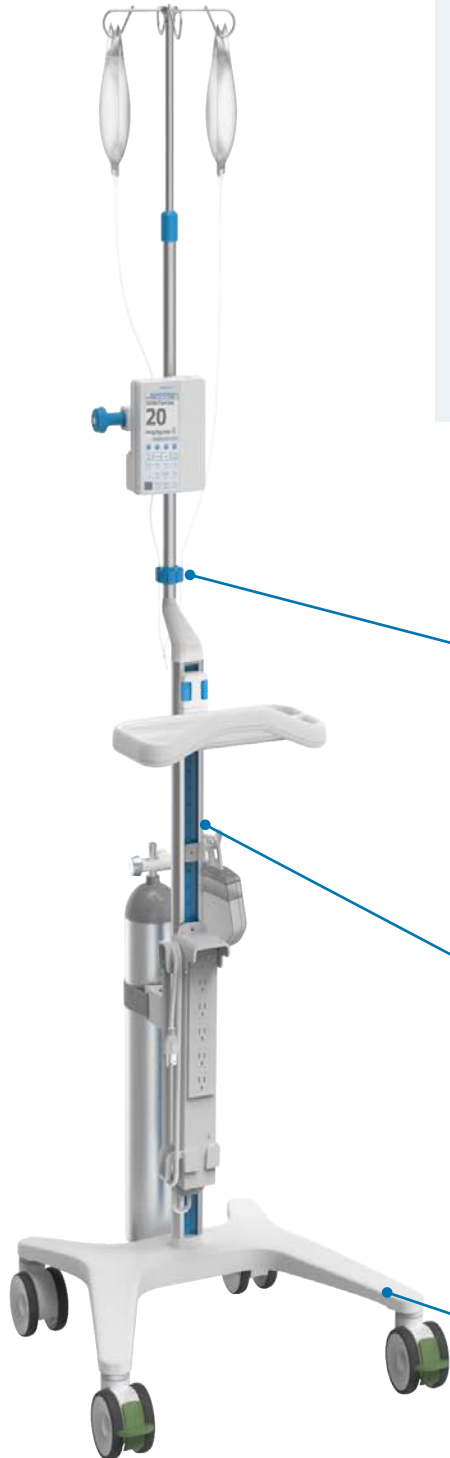

Controlled
Descending
Technology

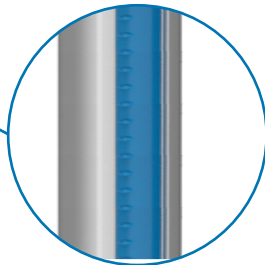

Techni-Track
for Maximum
Modularity

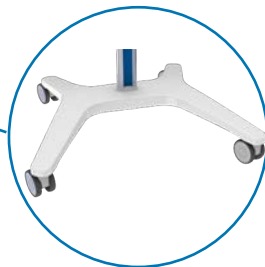

Ergonomic
Four-Caster Base

THIS ERGO IV STAND

FEATURES & BENEFITS

- Its unique top pole design ensures unblocked visibility while walking
- Integrates Controlled Descending patented technology in the IV pole for easier height adjustment and smooth pole sliding
- Facilitates a comfortable posture thanks to the height-adjustable ergonomic handle
- Its base is designed to provide better ergonomics and stability while walking
- Features Techni-Track patented technology for maximum modularity for accessory installation
- Offers multiple options for top poles with 4 stars or in-line IV bag hooks or 8 in-line IV bag hooks
- Optional single O₂ tank holder, drainage bag hook, tubing management, basket, hand sanitizer and glove box holders
- Medical grade power bar with surge protection
- Four 3-inch or 4-inch casters including two with breaking mechanism

OPTIONS

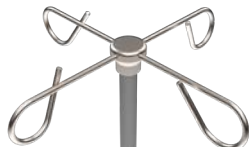

4 Stars Hooks



4 In-line Hooks



4 or 8 In-line Hooks



3-inch or 4-inch Casters including 2 brake mechanism

ACCESSORIES



Height Adjustable Ergonomic Handle



Drainage Bag Hook



Medical Grade Power Bar with Surge Protection



Hand Sanitizer Holder



Glove Box Holder

THS WORKSTATION ON WHEELS

A True WOW! Factor in the Hospital

The slim design of the THS Workstation on Wheels makes it easy to maneuver, yet very stable and versatile. The sit-to-stand height adjustable workstation can be customized according to your needs. It can receive an all-in-one computer, a standard computer set of CPU, monitor, keyboard, mouse, a laptop or a tablet. The Work Station on Wheels can also be equipped with various accessories such as different size drawers, articulated arm for single or multiple screens, a printer, battery and power bar holders.

As part of the THS family, the Workstation on Wheels features our patented technology: Techni-Track for maximum modularity and flexibility for accessory installation and interchangeability. It also features a telescopic column structure that facilitates height adjustment to improve ergonomics in the workspace.

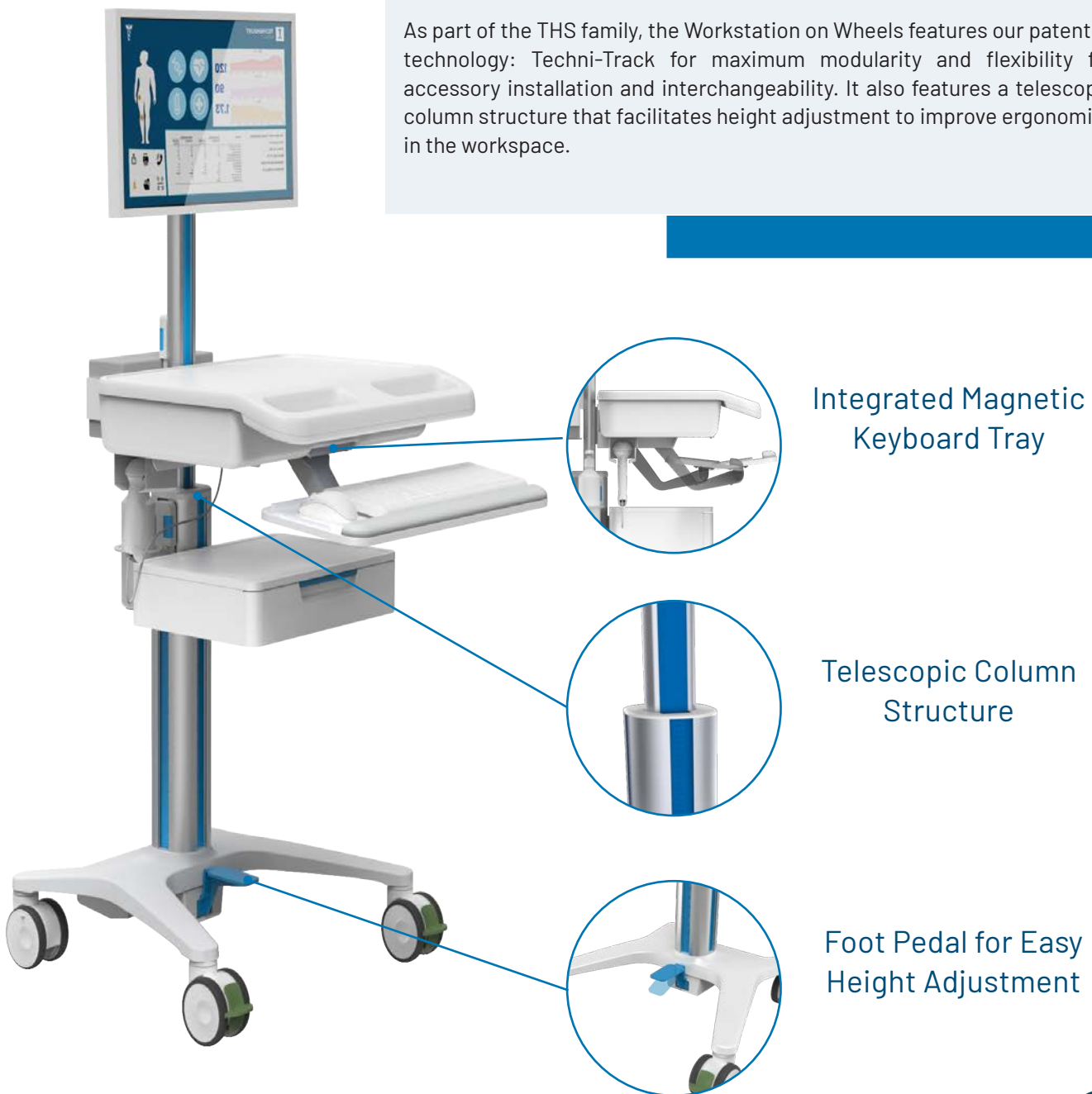

THIS WORKSTATION ON WHEELS

FEATURES & BENEFITS

- Slim and highly-stable design, the Workstation can fit in corridors or patient rooms
- Available in a single or double screen mount configuration or optional single screen articulated arm model
- Integrates Telescopic Column Structure for easier adjustment of the workspace
- Lightweight and wide working surface with integrated magnetic keyboard tray
- Features Techni-Track patented technology in its main structure for maximum modularity for accessory installation and cable management
- Different combination of drawer sizes available for a more custom configuration
- Highly customizable with optional handheld scanner, printer and power bar holders
- Medical grade power bar with surge protection
- Can fit a wide range of accessories such as a basket, hand sanitizer and glove box holder
- Four 3-inch or 4-inch casters including 2 with braking mechanism made of urethane and impact-resistant nylon

OPTIONS



Single Screen Mount



Dual Screen Mount



Single Screen Articulated Arm

ACCESSORIES



Printer Holder



Handheld Scanner Holder



Medical Grade Power Bar with Surge Protection



3" or 6" Height Drawers



Glove Box Holder

THS MEDICAL DEVICE STAND

One-of-a-kind Medical Device IV Stand that Integrate Ergonomics

Designed to bring the right equipment at the right place and at the right time, the THS Medical Device Cart can securely support specialized medical devices such as ventilators, monitors, defibrillators, or any other medical device with its accessories. Optionally, these carts can be equipped with our Universal Mounting Base allowing for complete compatibility with Technimount EMS' mounting systems for medical devices, making the transfers easier from an ambulance to the hospital.

As part of the THS family, the Medical Device Stand features our patented Techni-Track technology for maximum modularity and flexibility for accessory installation and interchangeability.

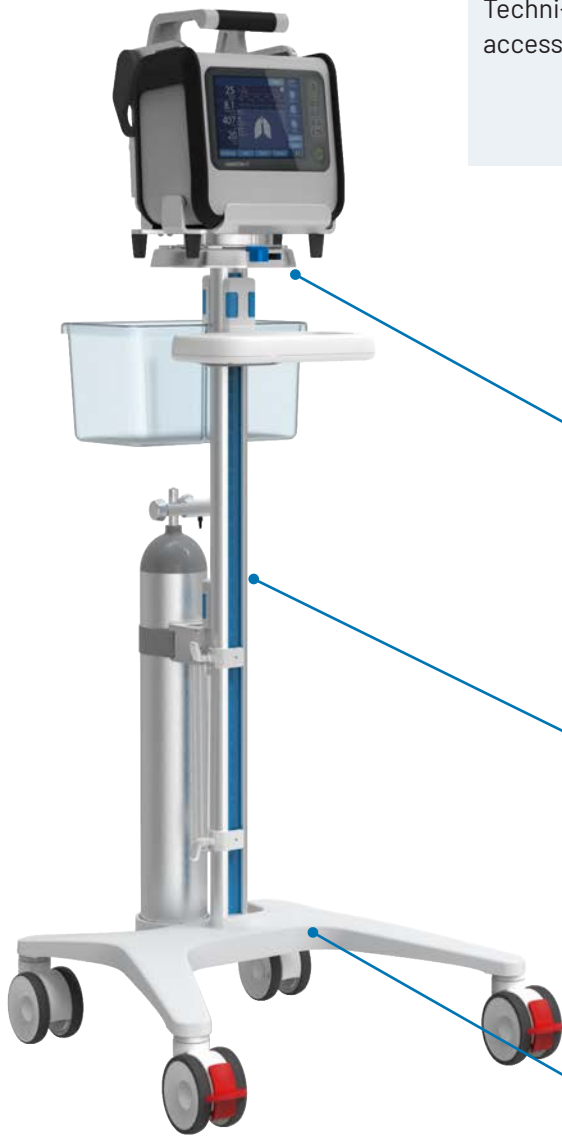

Multiple Device Interfaces Available



Techni-Track for Maximum Modularity

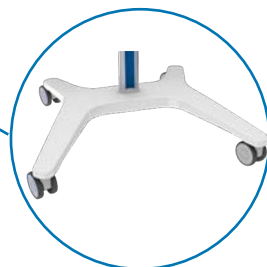

Highly-Stable Four-Caster base

THIS MEDICAL DEVICE STAND

FEATURES & BENEFITS

- Features Techni-Track patented technology in its main structure for maximum modularity for accessory installation
- Different device Interfaces available to accommodate most common medical devices
- Optional integration of Technimount Medical's Universal Mounting Base for maximum medical device compatibility with pre-hospital units
- Height-adjustable handle with optional integrated utility tray
- Optional single or double O₂ tank holder
- Drainage bag hook, and optional basket, hand sanitizer and glove box holders
- Medical grade power bar with surge protection
- Highly-stable and unique design base with white powder-coated paint
- Four 3-inch swivel casters including 2 with braking mechanism made of urethane and impact-resistant nylon

OPTIONS



Handle and 2 Baskets



Basket and Oxygen Tank Holder



Removable and Adjustable Accessories

ACCESSORIES



Height Adjustable Handle



Adjustable Basket



Medical Grade Power Bar with Surge Protection



Hand Sanitizer Holder



Glove Box Holder

THS WALL MOUNT SYSTEM

Ergonomics in Any Hospital Room

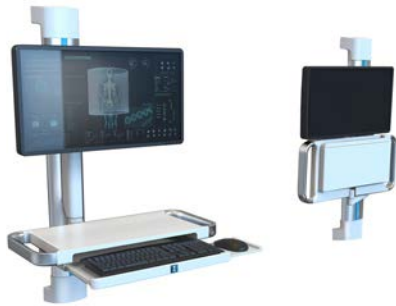

The Wall Mount System is designed to be installed either in an exam, operating, hallway or patient room with minimal space requirements. These workstations incorporate essential ergonomic features, such as height adjustment and a retractable arm to minimize its footprint when it is not in use.

As part of the THS family, the Wall Mount System features our patented technology, the Techni-Track for maximum modularity and flexibility. Its robust design structure allows for the installation of different models of monitors and all in-one computer monitors.

THS DOCKING STATION

Intra-Hospital Transfers Made Easy



Moving a patient in their bed from one care unit to another is now easier using the THS Docking Cart. Safely attached to virtually any type of hospital bed, the mounting system THS Docking Cart secures a multitude of medical devices and heavy equipment during intra-hospital transfers. Only one caregiver is required to move the patient and their equipment, maximizing the efficiency of staff.

As part of the THS family, the Docking Station features our patented technologies: Techni-Track for maximum modularity and flexibility for accessory installation and interchangeability, as well as Technimount's Controlled Descending technology integrated in its IV pole for an easier height adjustment and smooth pole descending.

THS TECHNI-CLAMP

Revolutionizing Medical Device Installation on Pole



THS Techni-Clamp is a true game changer in the medical practice. This patented technology allows for quick installation of pumps and other medical devices on IV pole and tubular structures in the most ergonomic way.

Its unique design allows for intuitive installation and removal of medical devices. Its original fastening mechanism secures the medical device in only a few turns. Highly versatile, the Techni-Clamp can accommodate the most used medical devices in the market.

Welcome to the new era of ergonomics and efficiency in installing medical devices on IV pole.

HERITAGE UNIVERSAL MOUNTING BASE

The Synergy Between Pre-Hospital and Hospital Services



Inspired by Technimount EMS Standard Surface Base which is at the center of the original concept that revolutionized medical device transport in the Emergency Medical Services (EMS) market, Technimount Medical's Universal Mounting Base becomes the missing link in the creation of efficiencies between pre-hospital and hospital services.

The Universal Mounting Base is compatible with all Bracket Pro Serie® products with a Standard Bottom Disc which are widely used in the EMS. Its versatility allows for easy installation on roll carts, crash carts, auxiliary arms and wall mounts. Its locking mechanism secures perfectly the medical device ensuring safety to Healthcare providers when in motion. Its unique design provides a 360° rotation and its quick release mechanism allows for easy access to medical device controls and increased flexibility.



TECHNIMOUNT
MEDICAL™

At Technimount Medical Inc. we understand that healthcare professionals need equipment that make their everyday practice easier. We design and develop quality solutions which are flexible and easy to use, allowing them to focus on what matters most - patient care.

Technimount Medical follows the same path as Technimount System, to continuously innovate to make healthcare practices more efficient and safer. Since 2013, Technimount System has been recognized as the leader in the Emergency Medical Services' industry, setting the standard in safe and flexible mounting systems for medical devices.

With the same mindset, Technimount Medical, an ISO 13485 certified company, creates distinctive products that respond to the ever-evolving healthcare practices. Our Technimount Healthcare System™ (THS™) and Healthcare Essentials product lines enable caregivers to move efficiently and safely all the medical devices needed to successfully treat their patients, wherever they are inside the hospital or remotely via telemedicine systems.

TECHNIMOUNT MEDICAL INC.

Corporate Headquarters
3770 Jean Marchand Street, Suite 100-B
Quebec (QC) G2C 1Y6
Canada
T + 1 581.700.6583
F + 1 855.339.6351
Toll-Free + 1 888.521.0871
technimount.com
info@technimount.com



TM THM 202205-01