



TECHNIMOUNT
EMS®

BRACKET PRO SERIE® 60 - GR

USER MANUAL

SAFETY AND FLEXIBILITY
WHERE IT MATTERS MOST



Copyrights

Copyright 2024 Technimount E.M.S. Holding Inc. (Technimount EMS) is an affiliated company of Technologies CGC Inc. All Rights Reserved. No part of this publication may be reproduced, transmitted, transcribed, stored in a retrieval system, translated in any language, modified in any form or by any means, without the written permission of Technimount EMS or its affiliate companies.

Trademarks

Product and medical device manufacturer names are Trademarks™ or Registered Trademarks® of their respective holders.

- Technimount EMS® and Bracket Pro Serie® are registered trademarks of Technologies CGC Inc.
- Hamilton-T1® is a registered trademark of Hamilton Medical.

For any issues with your Technimount product, its components, or for any technical questions during the installation, operation, or maintenance, please contact Technical Support at techsupport@technimount.com.

Contact Information

Technimount E.M.S. Holding Inc.

C/O: Regulatory Affairs

3770 Jean Marchand Street, Suite 100-C

Quebec (QC) G2C 1Y6

Canada

customerservice@technimount.com

techsupport@technimount.com

legal@technimount.com

www.technimount.com

T + 1 581.700.6613

TF + 1 888.639.2758 (North America)

Table of Contents

Copyrights	ii
Trademarks	ii
Contact Information	ii
1. General Mentions and Considerations	4
..... 1.1. Intended Use	4
..... 1.2. User Competency	4
..... 1.3. Warranties	4
..... 1.3.1. Warranty Policy	4
..... 1.3.2. Limited Warranty	5
..... 1.3.3. International Warranty Clause	5
..... 1.3.4. User Liability	5
..... 1.4. Claims	5
..... 1.4.1. Damaged or Defective Merchandise	5
..... 1.4.2. Return Policy	6
..... 1.4.3. Return of Material Authorization (RMA)	6
..... 1.4.4. Claim Process	6
2. General Safety Guidelines	7
..... 2.1. Symbols and Definitions	7
..... 2.2. Labels	8
..... 2.3. Safety Measures	9
3. Technical Specifications	11
4. Unpack the Bracket Pro Serie 60 - GR	12
5. Bracket Pro Serie 60 - GR Illustrated Parts	13
6. Maintenance	14
..... 6.1. Required Tools	15
..... 6.2. Condition-Based Maintenance Plan	15
7. Spare Parts	17

1. General Mentions and Considerations

Intended for the purchaser/supervisor, this user manual contains detailed product information and was designed to assist with the unpacking, assembling (when indicated), and maintenance of the Bracket Pro Serie 60 - GR mounting system. Its content should be relayed to EMS personnel during training. This document should be used with the operating guide, which contains specific user-related information such as the operating procedures and the daily safety checks.

NOTE: Technimount continually seeks advancements in product design and quality. While this user manual contains the most updated product information available at the time of printing, it may contain minor differences from the current version. For more information, please contact Customer Service at customerservice@technimount.com.

NOTE: The Bracket Pro Serie 60 - GR is available in a number of configurations. Although the illustrations within this document show the 2-disc option, the procedure herein applies to all model options. Follow the instructions that applies to your product model or refer to the "Technical Specifications" on page 11.

1.1. Intended Use

Mounting system designed to secure the Hamilton-T1® ventilator during ground EMS and critical care transport.

1.2. User Competency

The Bracket Pro Serie 60 - GR is intended for EMS personnel who have received the proper training, necessary to operate the device in the field, according to its intended use, as outlined in this user manual and operating guide. Please read all provided documentation thoroughly before using this device to ensure the safe operation of this device and provide a safe environment for patients and EMS personnel.

1.3. Warranties

1.3.1. Warranty Policy

This statement constitutes Technimount's entire warranty policy with regards to Technimount products. Technimount makes no other warranty or representation, neither expressed nor implied, except as stated herein. There is no warranty of merchantability or warranty of fitness for any particular purpose. Under no circumstances will Technimount be held liable hereunder for incidental or consequential damages, arising from or in any manner, related to sales or use of any such device.

Technimount E.M.S. Holding Inc. (Technimount) guarantees to the original "Purchaser" of the "Product" with which this "Limited warranty" is included, that the product will be free from "Defects" in workmanship and materials under normal use for a "Warranty period" of one (1) year from the product purchase date by the purchaser. During the warranty period, the product will be repaired or replaced according to the "Limited warranty" without charge to the purchaser for parts or labor. The parts and product may be repaired or replaced with new or refurbished parts or products. Herein this Limited Warranty, "Refurbished" means parts and products which have been returned to the factory, specifically. If the product is repaired or replaced within the warranty period, the greater of the remaining warranty period will apply, or three (3) months from the date of repair or replacement. If the product is repaired or

replaced after the warranty period has expired, the warranty period for the repair or replacement will expire three (3) months after the repair or replacement date.

1.3.2. Limited Warranty

Technimount products are intended to retain medical devices in place in the case of a single crash impact. Technimount products must not be reused if involved in a crash and must thereafter be replaced. If the end user uses a Technimount product following a crash, it is at the end user's own risk. Technimount will not be held liable.

The limited warranty does not apply to normal wear that could result from normal use. It does not apply when the product or any of its components have been disassembled or repaired by someone not authorized by "Technimount". It does not cover repair or the replacement of any product or part thereof damaged by neglect, misuse, moisture, liquids, exposure to heat, accidents, abuse, and non-compliance with the instructions for installation and use provided with the product.

The limited warranty does not cover physical damage to the surface of the product. The decision to repair, replace or refuse the coverage is final and at the sole discretion of Technimount, without any compensation or obligation from Technimount. The product defined as a "Mounting system", "Mounting solution" or "Bracket" used to attach and secure the medical devices, is specifically designed to fulfill this requirement. Any other use will void the warranty and Technimount shall not be held liable on any claim if the product has been modified or adapted for use.

1.3.3. International Warranty Clause

This warranty abides by the Canadian domestic policy. Warranty outside Canada may vary by country. Please contact Customer Service at customerservice@technimount.com for more information.

1.3.4. User Liability

The purchaser and administrator are responsible to validate regulations and standards for safety in their region, to comply with applicable safety regulations. Technimount is not responsible to inform the purchaser or the administrator of any applicable legislation for safety in their area.

The administrator is responsible for providing proper training to any personnel who will install, operate and perform maintenance on Technimount products.

1.4. Claims

1.4.1. Damaged or Defective Merchandise

ICC Regulations require that claims for damaged merchandise must be made with the carrier within fifteen (15) days of the reception date. Do not accept damaged merchandise unless such damage is noted on the delivery receipt at the time of reception. Upon prompt notification, Technimount will file a freight claim with the appropriate carrier for damages incurred. Claims are limited in amount to the actual replacement cost. If the claim has not been received by Technimount within the fifteen (15) day period following the date of delivery, or the damage was not noted on the delivery receipt at the time of receipt, the customer will be responsible for the full payment of the original invoice.

Claims for any short or broken merchandise must be made within thirty (30) days of invoicing. For details, refer to the claim process or contact Customer Service at customerservice@technimount.com.

1.4.2. Return Policy

Technimount's mounting and bracket systems for portable medical device may be returned up to sixty (60) days from the reception date, if:

- The received product does not match what was originally ordered.
- The product does not meet the Technimount technical sheet specifications.
- The product is not compatible with the device on which it was intended to be installed onto.

To return a Technimount product,

- A Return of Merchandise Authorized (RMA) must be requested and approved by Technimount prior to returning the product.
- Products must be returned undamaged and in its original packaging, appropriately identified with the approved RMA number. Returns will not be approved on a modified or damaged item.
- Charges may apply if the package received is damaged or items are missing.
- Purchaser is responsible for a restocking fee (refer to Table 1).

Table 1: Restocking fees

RESTOCKING FEES	
Prior to thirty (30) days	10%
Prior to forty-five (45) days	25%
Prior to sixty (60) days	30%

For any manufacturing defect, refer to the conditions within the warranty policy or contact Customer Service at customerservice@technimount.com for additional information.

1.4.3. Return of Material Authorization (RMA)

The Technimount Customer Service department is responsible for all merchandise returns and will provide a Return of Merchandise Authorization (RMA) number, upon approval. The RMA must be printed and placed on the returned merchandise. Technimount reserves the right to charge shipping and restocking fees (refer to Table 1) for the returned items. Special, modified, or discontinued items are not subject to returns.

1.4.4. Claim Process

Upon reception of the returned merchandise, a thorough inspection will be performed. If the merchandise is compliant with the return policy or it is found that the product is defective, Technimount will take corrective actions and close the claim. If, however, it is found that the product is not defective, but rather misused or abused, the product will not be covered by the warranty. Details of our findings and conclusions will be provided shortly thereafter. To submit a claim, contact Customer Service at customerservice@technimount.com to obtain a Return of Material Authorization (RMA) form and return instructions.

2. General Safety Guidelines

Pictograms, safety symbols and labels are used to alert the user to a potentially hazardous situation, which, if not avoided, may result in minor or moderate injury to the user or patient or cause damage to the device or other property. This includes the special care necessary for the safe and effective use of the device to avoid damage that may occur from use or misuse. The terms "Warning" and "Caution" herein carry special meaning and should be carefully reviewed.

WARNING - Indicates a hazardous situation that, if not avoided, could result in death or serious injury.

CAUTION - Indicates a hazardous situation that, if not avoided, could result in minor or moderate injury.

Always read and abide by all the safety guidelines identified within this document.

2.1. Symbols and Definitions



WARNING - General Warning

Alerts the reader of a potentially hazardous situation, which, if not avoided, may result in death or serious injury to the user or patient or cause damage to the device or other property. This includes the special care necessary for the safe and effective use of the device to avoid damage that may occur from use or misuse.



CAUTION - Safe Working Load/Load Balance

Indicates the total maximum charge for a safe use of device.



CAUTION - General Mandatory Action

Call for action. Alerts the reader to potential risk to people not following the mandatory action specified by the supplementary sign.



CAUTION - Follow Instructions for Use

Call for action. Reminds the reader to consult the user manual for information.

2.2. Labels

Labelling on the surface of the Technimount product, quickly identify potential risks, contains the serial number and provides information to the user. A manufacturing label, including the serial number (Figure 1), can be seen on the Technimount product

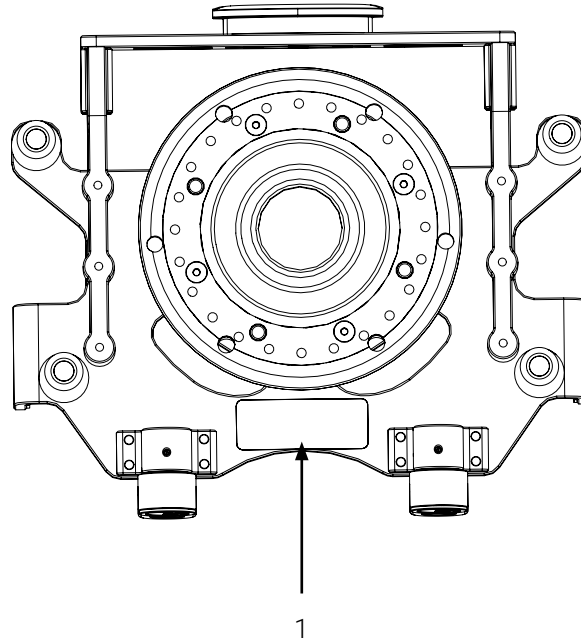

1. Manufacturing label

Figure 1: Location of the manufacturing label (bottom of bracket illustrated)

2.3. Safety Measures

Carefully read all safety measures herein before installing, operating, or performing the maintenance of the Technimount product.



WARNING - Risk of Injury

Regulations and standards for safety are the sole responsibility of the end user. Ensure that the installation specifications meet the local and regional compliance requirements before use. Product incompatibility could cause unpredictable functioning resulting in injury to the patients or EMS personnel.



WARNING - General Warning

- **Do not perform** safety checks or maintenance on the Technimount product before having received the proper training.
- The administrator is responsible for providing proper training to any personnel who will install, operate and perform maintenance on Technimount products.
- Improper use of the Technimount product may damage the device or cause injury to the patients or EMS personnel.
- If any serious incident occurs with the mounting solution, immediately stop using the product, report this incident to Technical Support at technicalsupport@technimount.com and the applicable regulatory agency.
- Always keep the user manual and operating guide within reach of the cart, even if the system is subsequently sold, to prevent undue risk to the product, patients, and EMS personnel. The user documentation is an integral part of the system.
- Always refer to the applicable environmental laws, waste directives and regulations specified in your local (national or regional) environmental policies and/or Safety Data Sheets (SDS), when applicable.



CAUTION - Safe Handling and Operation

- **Do not modify** the product, or any of its components and use only as described in this user manual. Modifying the product or improper use could cause unpredictable functioning, resulting in injury to the patients or EMS personnel.
- Both (2) rotary locks must be in the locked position  to properly secure the medical device in the bracket and prevent it from falling from the mounting system during transport.



CAUTION - Safe Practice

- Always pay close attention to the condition of the rotary locks and safety mechanisms, to prevent undue risk to the device, patients, and EMS personnel.
- Practice installing, removing and safely operating the medical device until the manipulations have been perfected, before use with patients. Improper use of any Technimount product may damage the device or cause injury to the patients or EMS personnel.
- Follow the recommended maintenance plan and its guidelines, as described in this user manual and operating guide.



CAUTION - Working Load/Load Balance



Do not overload the system. The Safe Working Load (SWL) is 17.3 lb (7.9 kg).



CAUTION - Follow Instructions for Use

- Always read and abide by all the safety guidelines identified, as well as follow instructions provided within this document.
- Refer to the manufacturer's user manual for safety precautions and user instructions for the safe use of the Hamilton-T1 ventilator.

3. Technical Specifications

Product Name	Bracket Pro Serie® 60 - GR
Description	Mounting system designed to secure the Hamilton-T1® ventilator during ground EMS and critical care transport
Part Code	<ul style="list-style-type: none"> - 700-23-HM (bottom disc) - 700-24-HM2D (bottom and back discs)
Features	<ul style="list-style-type: none"> - Rotary locks for easy installation and removal of the ventilator - Suited for installations on surfaces, stretchers and carts - Feet
Operating Environment	EMS/CCT (Ground)
Compliance	Tested in compliance with SAE J3043 and AMD-028
Compatible Mounting System	<ul style="list-style-type: none"> - Standard Surface Base - Micro Base - Wall Mount Systems - Safety Arm System - Safety MD-Transporter® - Floor Mount System
Dimensions (W X D X H)	<ul style="list-style-type: none"> - 700-23-HM: 11.5 in. X 10 in. X 11.8 in. (29.2 cm X 25.4 cm X 30 cm) - 700-24-HM2D: 11.5 in. X 10.6 in. X 11.8 in. (29.2 cm X 26.9 cm X 30 cm)
Weight	<ul style="list-style-type: none"> - 700-23-HM: 5.6 lb (2.5 kg) - 700-24-HM2D: 5.9 lb (2.7 kg)
Composition	<ul style="list-style-type: none"> - Bracket: aluminum 6061-T6 with silver anodized finish - Standard bottom disc: aluminum 6061-T6 with 304 stainless steel inserts and peek fibre cushions - Anti-rotation micro disc: aluminum 6061-T6 with silver anodized finish - Feet: acetal
Safe Working Load (SWL)	17.3 lb (7.9 kg)
Operating Temperature	- 31° F to 113° F (- 35° C to 45° C)
Installation	<ul style="list-style-type: none"> - The ventilator is installed in the bracket and secured by two (2) rotary locks - The bracket is installed in the Standard Surface Base and/or Micro Base and secured by a safety mechanism with quick release button
Model & Configuration Options	Contact Customer Service at customerservice@technimount.com

4. Unpack the Bracket Pro Serie 60 - GR

1. Inspect the shipping box(es) for signs of damages, before accepting shipment. Take pictures and report them promptly if applicable.
2. Move the shipping box(es) to the location of the installation.
3. Open the shipping box(es).
4. Unpack the box(es) and ensure that all shipping and packaging materials have been properly removed, prior to installation.

NOTE: Keep all packaging material for future use.

5. Identify all the components and hardware included for installation, then set aside. Refer to Section 5 for the illustrated parts, if needed.
6. Inspect the items for signs of damages. Take pictures and report them promptly if applicable.

5. Bracket Pro Serie 60 - GR Illustrated Parts

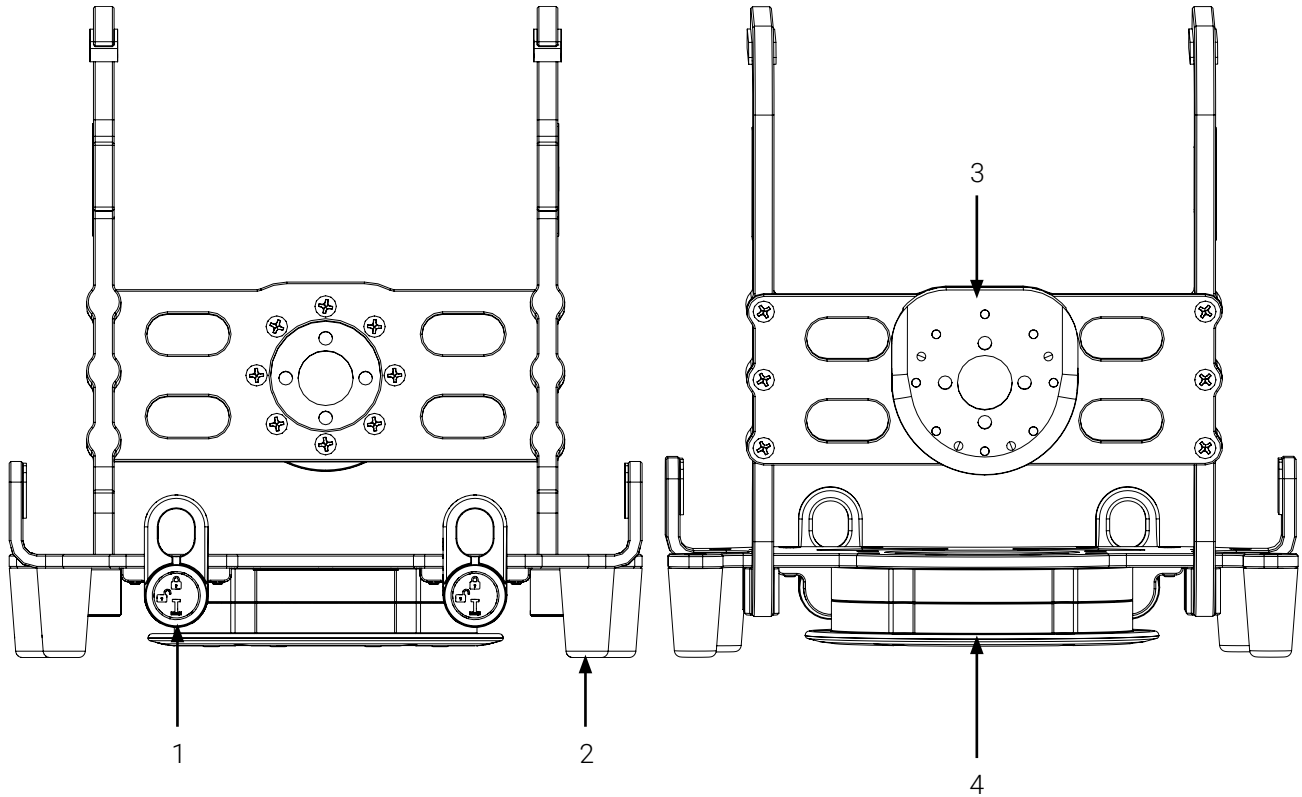

- | | |
|---------------------|-----------------------------|
| 1. Rotary lock (2X) | 3. Anti-rotation micro disc |
| 2. Foot (4X) | 4. Standard bottom disc |

Figure 2: Bracket Pro Serie 60 - GR illustrated parts (Front and rear of 2-disc bracket illustrated)

6. Maintenance

Daily safety checks (refer to the Bracket Pro Serie 60 - GR Operating Guide) and a condition-based maintenance plan (Section 6.2) are required and should be established for all Technimount devices. Factors such as weather, environment, geographical location and individual usage will necessitate different needs. For the maintenance of the Bracket Pro Serie 60 - GR, follow the guidelines listed in the user manual, operating guide and in accordance with your service's current maintenance practices and protocols.

NOTE: Always keep records of your all maintenance activities and immediately remove defective or expired products from your inventory.

Please contact Technical Support at techsupport@technimount.com for replacement parts or repair related issues.



WARNING - General Warning

- **Do not perform maintenance** on Technimount products, before receiving proper training.
- Perform maintenance operations, as described in this user manual. Failing to follow the recommended maintenance plan or its guidelines could cause premature damage to the product.
- Use only Technimount parts, maintenance procedures, cleaning solutions and lubricants, as described in this user manual. Using unapproved modified parts or procedures for the installation, operation, or maintenance of the Technimount product may cause the device to be unstable and could cause injury to the patients or EMS personnel and void the product warranty.
- Replace damaged or worn-out parts if past their expected service life or when damaged (refer to the Technical Specifications in Section 3 of this user manual). Recycle damaged parts or dispose according to the environmental laws that apply to your jurisdiction and consult the Safety Data Sheets (SDS).



CAUTION - Safe Handling and Operation

- **Do not steam clean** or use ultrasonic cleaners on the system or any of its components.
- **Do not immerse** the metal parts/components in water.
- To spot clean, the maximum water temperature should not exceed 180° F/82° C. The maximum water pressure should not exceed 1500 psi/103.5 BAR. If using a pressure washer to clean the unit, the pressure nozzle must be kept a minimum of 24 in. (61 cm) from the unit.
- Always rinse and dry the Bracket Pro Serie 60 - GR properly after using cleaning products. Certain types of cleaners may leave a corrosive residue on the surface of the product and could cause the premature corrosion of critical components. Refer to the product Safety Data Sheets (SDS) for chemical information or handling, storage and emergency measures in case of accident.



CAUTION - Corrosion

- Some cleaning products are corrosive in nature and may cause damage to the product if used improperly. When cleaning, always use appropriate Personal Protection Equipment (PPE) based on established protocols (e.g., gloves, eyewear, etc.).
- Dispose of corrosive wastes according to the environmental laws that apply to your jurisdiction and consult the Safety Data Sheets (SDS).



CAUTION - Follow Instructions for Use

Always read and abide by all the safety guidelines identified, as well as follow instructions provided by the manufacturer of the cleaning product(s).

6.1. Required Tools

- Clean dry cloths
- Soft brush
- Sodium Thiosulfate solution

6.2. Condition-Based Maintenance Plan

Condition-based maintenance is carried out by the maintenance supervisor when the safety checks have revealed underlining issues that need immediate attention and/or to prolong the longevity of the system in optimal conditions. The maintenance supervisor should perform condition-based maintenance minimally every three (3) months, or when required. In case of a non-conformity, immediately stop using the product and contact Technical Support at technicalsupport@technimount.com for a remedial action plan.

CONDITION-BASED MAINTENANCE	DONE	
	YES	NO
TASKS		
Safety Checks	<input type="checkbox"/>	<input type="checkbox"/>
Perform the safety checks to get an overview of the system's current condition, referring to the Bracket Pro Serie 60 - GR Operating Guide.		
Clean the System	<input type="checkbox"/>	<input type="checkbox"/>
1. If needed, remove the excess dirt on the mounting system's disc(s) using a soft brush.		
2. Remove the contaminants using a power washer.		
3. Clean using a solution of 0.13 oz/3.70 ml Sodium Thiosulfate in 1 pt./0.5 L in lukewarm water and a clean cloth.		
4. If needed, spot clean stains by applying the solution directly on the stain and let sit on the surface.		
NOTE: Avoid over saturation and ensure that the product does not sit on the surface of the bracket longer than recommended by the cleaner's manufacturer.		
5. Thoroughly rinse the solution with a clean cloth dampened with lukewarm water, then towel dry all the components before returning to service.		
Inspect the Hardware	<input type="checkbox"/>	<input type="checkbox"/>
1. Make sure all the screws are accounted for and that they are leveled with the surface in which they are screwed.		
2. Make sure there are no loose screws.		
Technimount Standard Surface Base and Micro Base	<input type="checkbox"/>	<input type="checkbox"/>
Perform the recommended condition-based maintenance on the mounting system's base(s), as described in the user documentation provided with each component.		

CONDITION-BASED MAINTENANCE

DONE

Condition-Based Maintenance completed on (dd/mm/yyyy) .

Condition-Based Maintenance completed by .

Comments and observations:

7. Spare Parts

Technimount reserves the right to change part numbers and products without notice. Please contact Customer Service at customerservice@technimount.com to ensure product options and availability, or Technical Support at techsupport@technimount.com for replacement parts or repair related issues.

PART/KIT NUMBER	PART/KIT DESCRIPTION
9001-10-UN	Rotary lock
923-00-1625-INS ¹	Acetal foot, 1- ⁵ / ₈ in. (hardware included)
Contact Customer Service	Bracket Pro Serie® mounting systems

¹ Installation requires high strength thread lock adhesive #262



TECHNIMOUNT

EMS[®]

Technimount EMS offers mounting solutions that can be installed on ambulance counters, walls and stretchers which allows for the equipment to follow the patient throughout the continuum of care. Our unparalleled level of flexibility allows for maximum operability in EMS, hospital and military environments.

Technimount EMS is driven to offer innovative solutions that respond to the unique device management needs of emergency and Critical Care Transport (CCT) teams for ground and air ambulances. Safety is at the core of our values, all Technimount systems are tested in compliance with the highest industry standards for impact resistance. Technimount EMS is committed to developing innovative solutions as healthcare practices evolve.

TECHNIMOUNT E.M.S. HOLDING INC.

3770 Jean Marchand Street, Suite 100-C
Quebec (QC) G2C 1Y6
Canada
T + 1 581.700.6613
TF + 1 888.639.2758 (North America)

technimount.com